

SULZER

Flow Equipment

HSR turbocompressor



Main industries and applications

The HSR turbocompressor is highly suitable for providing oil-free air in the following industries:

- pulp, paper and board
- food and beverage
- chemical processing
- pharmaceutical and medical
- electronics manufacturing
- textile manufacturing

Using a high-speed, premium-efficiency motor and digitally controlled magnetic bearings, the HSR range of turbocompressors offers truly outstanding wire-to-air efficiency. In other words, it gives you the best total output for your energy input.

Turbocompressors from Sulzer have a solid reputation for quality and reliability. Our technology has been tried and tested over two decades of operation.

The highly efficient HSR means substantial savings: lower energy consumption, reduced operating costs, lower maintenance costs and less downtime caused by breakdowns. By choosing the HSR you will also contribute to a healthier working environment and reduce your plant's carbon footprint.

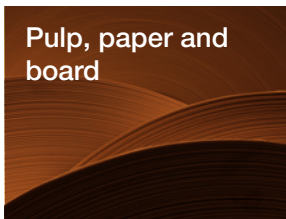

Pulp, paper and board



Food and beverages



Chemical process industry



General industry



Features and benefits

1 Totally oil free

- To satisfy the toughest quality requirements on air quality and to eliminate the risk of end product contamination, the HSR contains no oil whatsoever.

2 High overall efficiency

- An excellent combination of superior, well-proven designs ensures energy savings and lower lifecycle cost.

3 Magnetic bearings

- No other solution offers the same efficiency, stability or component life.
- The condition of the machine is monitored continuously.

4 Compact package

- The turbocompressor has small dimensions.
- The design allows new compressor rooms to be optimally designed and enables the easy replacement of older, inefficient equipment.

5 Superior capacity control

- Speed control offers the widest operating range at a good efficiency.
- If air demand falls below the minimum flow of the compressor element, the HSR offers either highly efficient cycling (idle-run) or precision regulation with blow-off valves that are adjustable down to no flow.

6 Heat recovery built in

- The advanced liquid cooling system enables easy energy recovery.
- Up to 93% of the compressor power consumption can be recaptured for process, heating or other needs.

7 Lowest cost of maintenance

- No gears, no oil and no mechanical bearings means that all maintenance is clean, efficient and predictable. Hence it will also cost less than for any comparable equipment.



High-speed technology

Turbocompressors from Sulzer have a solid reputation for quality and reliability. The unique high-speed technology, which has been tried and tested over two decades of operation, can be found today in thousands of turbocompressors worldwide.

Minimum number of moving parts

Conventional compressors may contain hundreds of moving parts. In turbocompressors built with high-speed technology, the only moving components are the shafts that function as the motor's rotors, upon which the impellers are directly mounted.

No contact, no wear

The magnetic bearing technology provides a level of control that ensures optimal mechanical clearances. Even during starts and stops, there is never any contact between the rotating and static parts. When HSR turbocompressors are powered up, the rotors are lifted by the balanced magnetic forces. Only when the rotors are fully aloft is the variable-frequency current fed to the motor windings, which causes the rotors to turn. This means there is no mechanical wear. The result is a compressor with no performance degradation and minimal need for scheduled maintenance.

Real-time monitoring built in

The use of magnetic bearings makes it possible to know what is happening in the turbocompressor at all times, and this means maximum protection against unscheduled stoppages. If any undue rotor movement is identified, the bearing controller will compensate for it within microseconds – and issue a warning if the problem is severe. If all else fails, the controller will trigger a fault and stop the turbocompressor, thus protecting the machine. This is a unique feature of active magnetic bearing technology.

Vibration-free

Because the position of the rotor is monitored and adjusted thousands of times per second, the turbocompressor does not vibrate during operation. If any slight mechanical imbalance exists after the thorough balancing of the rotor, the controller compensates for it by adjusting the rotational patterns at the rotor ends. This minimizes uncomfortable machine noise from the turbocompressor or from any attached or adjacent equipment.

No oil whatsoever

Our high-speed technology is 100% oil-free. The magnetic bearings work without physical contact, and there is no need for lubricating oil, oil pumps or oil cooling. This means there are no oil levels to monitor, and no oil leakage to threaten product safety or the working environment. As the condensate contains no traces of oil, it is easily disposed of.

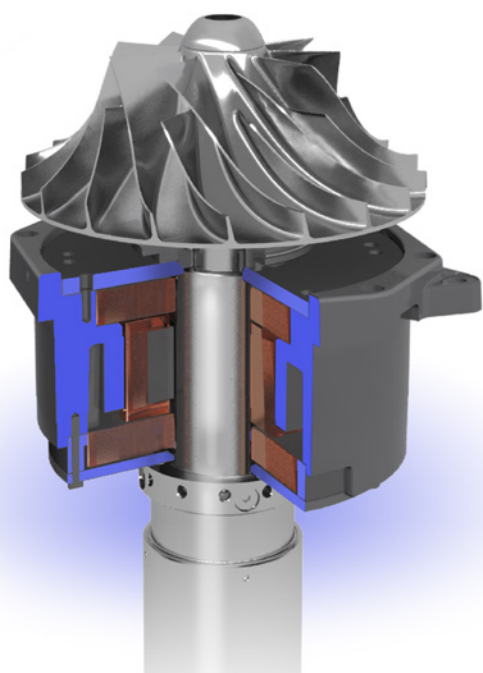

Magnetic bearings eliminate physical contact and thereby all mechanical wear.

Motor efficiency through design

The turbocompressor's synchronous motor is of a permanent magnet type and is specifically designed for the turbocompressor. Only premium materials are used in its construction. The result is an electrical efficiency that no combination of off-the-shelf parts can match.

From the originator of high-speed technology

The first Sulzer high-speed turbocompressors were delivered in 1996. These were the very first direct-driven high-speed turbocompressors for low-pressure applications. All of the experience from their many years of operation has been used in creating Sulzer's current state-of-the-art compressor products.

- ① Rotor
- ② Stator
- ③ Motor frame
- ④ Low pressure impeller
- ⑤ High pressure impeller
- ⑥ Axial bearing
- ⑦ Radial bearing
- ⑧ Air suction
- ⑨ Air discharge

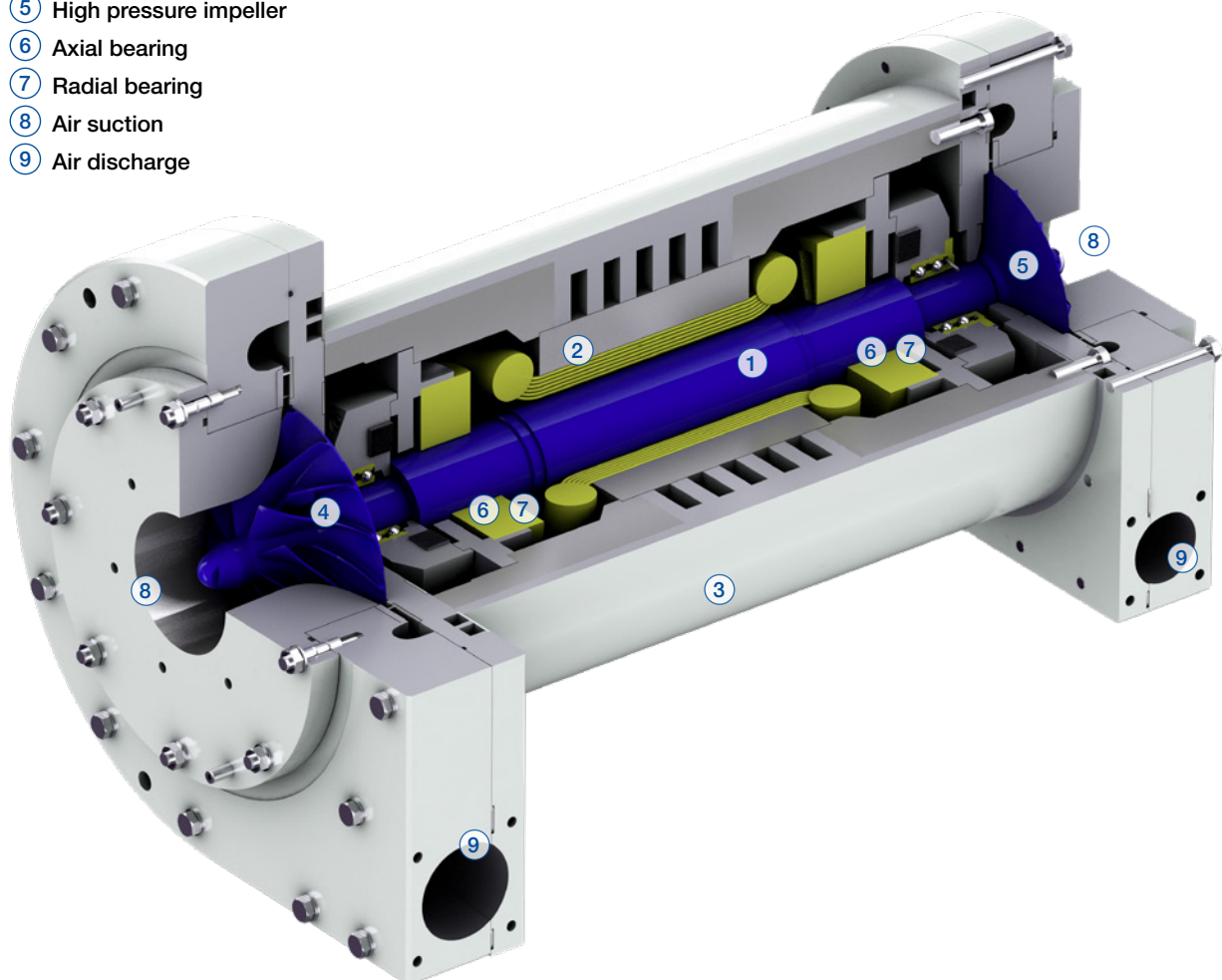

Specifications

Materials

Part	Material
Impeller	Titanium
Volute and backplate	Aluminum alloy
Motor	Aluminum alloy
Enclosure	Plated steel
Shaft	Steel

Operating data

	2-stage version	3-stage version
Pressure	2 - 5 bar (g) 30 - 70 psig	5 - 9 bar (g) 70 - 130 psig
Volume flow	max. 33 m ³ /min 1'165 cfm	max. 53 m ³ /min 1'872 cfm
Input power	115 - 135 kW 154 - 181 hp	145 - 325 kW 194 - 436 hp
Input voltage	380 - 480 V	380 - 480 V
Input frequency	50 - 60 Hz	50 - 60 Hz
Protection class	IP33D	IP33D
Max. noise level	76 dB	76 dB

Performance range

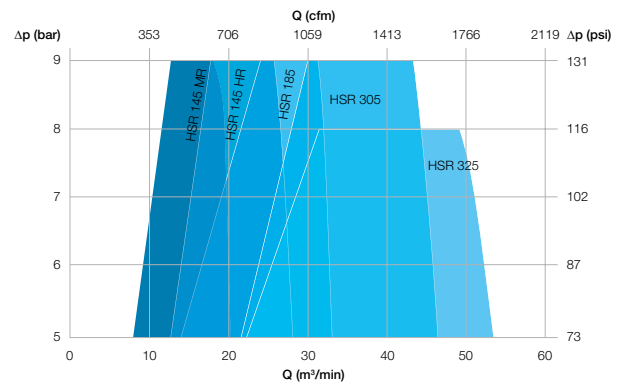
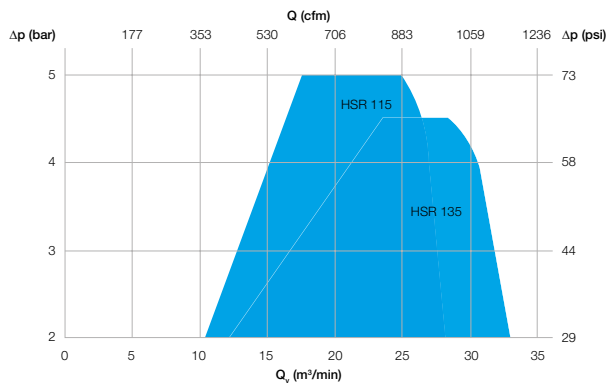

We keep your processes flowing

Wherever fluids are treated, pumped, or mixed, we deliver highly innovative and reliable solutions for the most demanding applications.

Our offer

The Flow Equipment division specializes in pumping solutions specifically engineered for the processes of our customers. We provide pumps, agitators, compressors, grinders, screens and filters developed through intensive research and development in fluid dynamics and advanced materials. We are a market leader in pumping solutions for water, oil and gas, power, chemicals and most industrial segments.



Pumps

As one of the world's leading pump manufacturers, Sulzer provides a wide range of products for engineered, configured, and standard pumping solutions as well as essential auxiliary equipment. We are renowned for our state-of-the-art products, performance reliability and efficient solutions.



Agitators and dynamic mixers

Sulzer mixing and agitation technology offers a wide range of products for industrial applications. Side-mounted horizontal and top-mounted vertical agitators, dynamic chemical mixers, and tower and tank flow management products guarantee effective mixing and agitating processes.



Compressors and aeration

Sulzer's state of the art offering for municipal and industrial wastewater treatment includes turbocompressors, aeration systems and mechanical aerators. Our application and process know-how combined with our unique product portfolio give us the means to provide customers with reliable and efficient solutions.



Submersible mixers

Sulzer's energy efficient submersible mixers are suitable for a wide range of applications in industry and municipal treatment plants. They provide the right solution to match mixing tasks for agitating, blending, mixing, dissolving and suspension of solids in industry and municipal treatment plants.

The Sulzer Flow Equipment division keeps your processes flowing. Wherever fluids are treated, pumped, or mixed, we deliver highly innovative and reliable solutions for the most demanding applications.

The Flow Equipment division specializes in pumping solutions specifically engineered for the processes of our customers. We provide pumps, agitators, compressors, grinders, screens and filters developed through intensive research and development in fluid dynamics and advanced materials. We are a market leader in pumping solutions for water, oil and gas, power, chemicals and most industrial segments.

E10576 en 3.2024, Copyright © Sulzer Ltd 2024

This brochure is a general presentation. It does not provide any warranty or guarantee of any kind. Please, contact us for a description of the warranties and guarantees offered with our products. Directions for use and safety will be given separately. All information herein is subject to change without notice.

