

Mixing and Reaction Technology

Pace Setting Technology

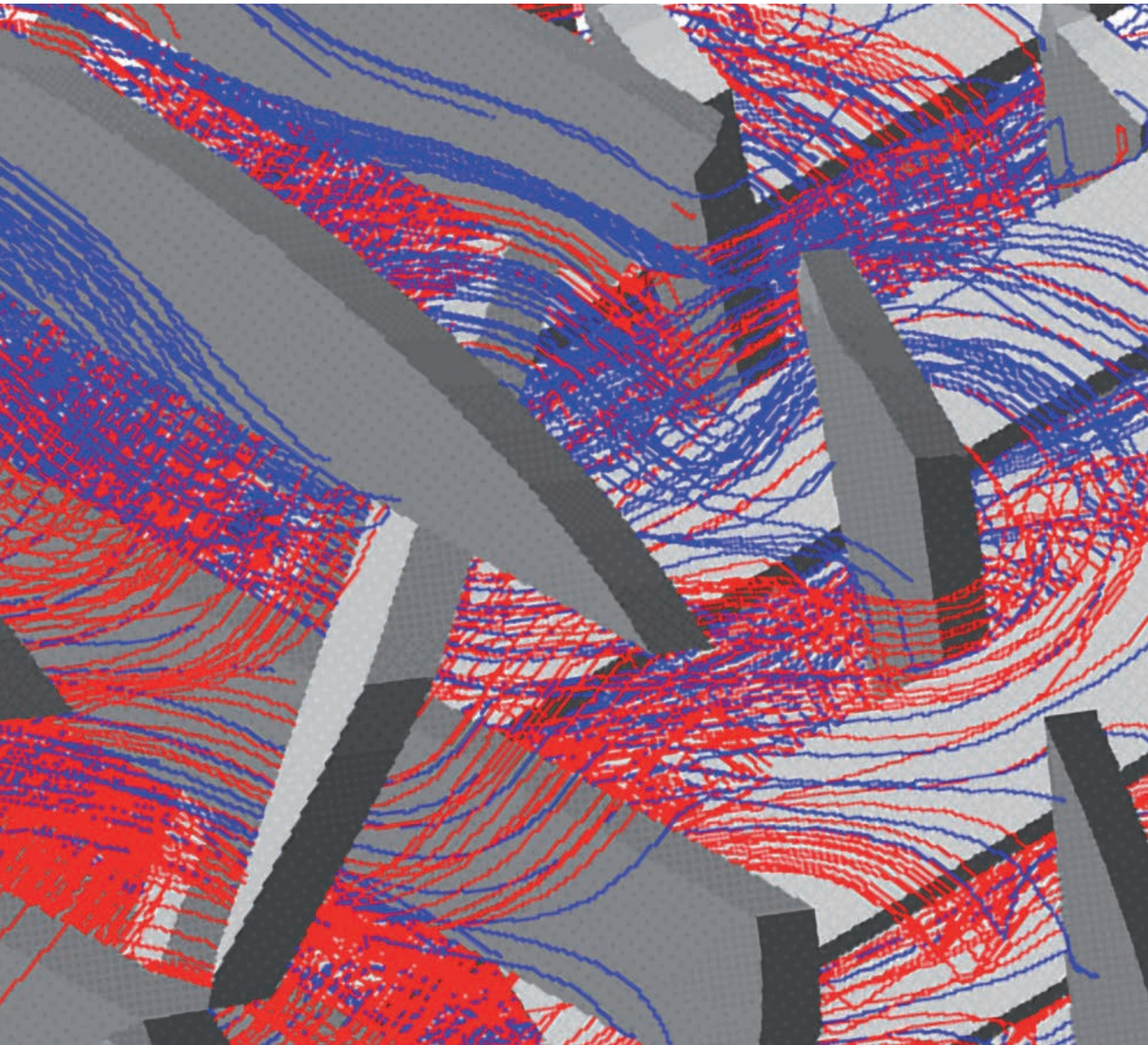

Sulzer Chemtech – Mass Transfer Technology

Your Partner in Separation and Mixing Technology

The Highest Level of Application Know-how

Our team provides state-of-the-art expert know-how for more than 500 applications in 100 processes, this enables us to optimize the performance and your installation.

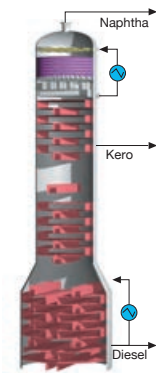

Fast and Reliable Turnaround Services

We don't shut-down, when you shut-down. You can rely on Sulzer professionals, expertise and procedures to get you back and running in the shortest possible time.



Comprehensive Engineering and Technology Services

We provide a full scope of associated engineering and technology services to optimize or trouble-shoot your installation.



A Broad Range of Innovative and High-performing Products

Our more than 200 products cover a wide range of needs in the field of separation and mixing technology.

They have proven their performance in more than 100,000 columns, 40,000 gas/liquid separators and 100,000 mixers in operation worldwide.



0602 2510

MellapakPlus™ Packing

Often copied, never equaled

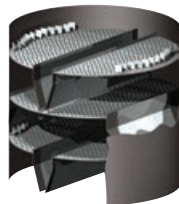

0605 2504

VGPlus™ Trays

One of the best high performance trays ever tested at FRI



0603 2535-3

NeXRing™

The next big thing in random packing



0694 2720

SMV™ static mixer

High mixing efficiency combined with large turn-down processing capabilities



Dusec Plus™ Coalescer

High performance with minimum pressure drop

Sulzer Mixing and Reaction Technology Pacesetter Technology for Mixers	3
Selection of Mixers for Your Application	4
Solid Application Expertise	10
Comprehensive Engineering Services	23

Sulzer Mixing and Reaction Technology Pacesetter Technology for Mixer

Since early 1970s Sulzer Chemtech has pioneered static mixing to enable homogenization and dispersion of liquids and gases without resorting to moving parts.

The ongoing development and innovation brought diversification in the area of heat- and mass transfer and reaction technology over a wide range of fluid properties and process conditions.

Today, we are the undisputed market and technology leader, serving the global needs of our customers with the widest range of products and applications. Our solutions are backed by the experience of more than 100'000 references and the latest methods in development, client testing, engineering and fabrication to meet the processing challenges of our customers and create long term benefits.

With technical sales offices all over the world and four regional centres supporting them, Sulzer is able to provide you with the same excellent service around the globe.

With manufacturing capabilities around the regions, distances to your factories are kept short which supports a quick delivery.

Decades of Experience!

- Well established methodology for scale ups
- R&D facilities existing and testing equipment available
- Improvement of your process reliability, energy consumption and product quality



Selection of Static Mixers

Static mixers are an arrangement of mixing elements installed in a pipe or duct. They function without moving parts and are used to achieve specific mixing and dispersion in continuous processes.

The mixing process is not random. Rather, it follows precise patterns. The performance is therefore predictable. Scale-up methodology is well defined depending on the process objective.

Static mixers are compact, robust, and essentially maintenance free. They perform over a broad range of conditions. Operating and investment costs are low compared with those of dynamic mixers.

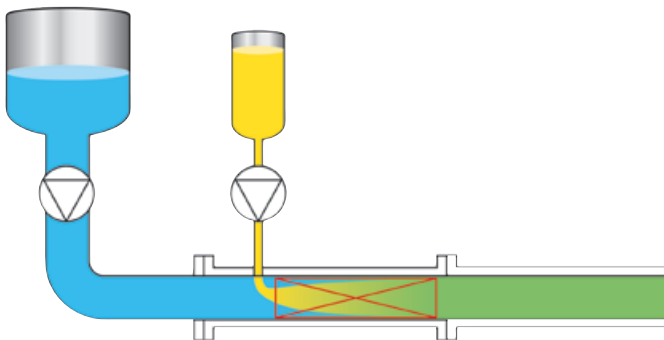

Picture 1: Static mixers are applied in continuous processes.

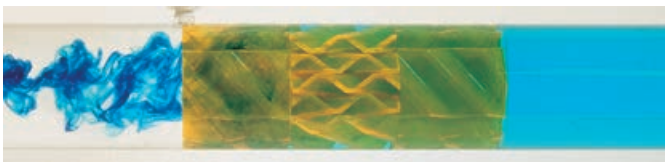

Turbulent mixing in an SMV mixer with 3 mixing elements.

Mixing is one of the most important unit operations. The quality of mixing and dispersion and the rate it is achieved often have a major impact on the product quality, production yield and overall process economics.

The correct selection and design of the applied static mixer is therefore of high importance. Take advantage of 40 years of experience of Sulzer in thousands of applications!

Mixers tailored for specific applications

Sulzer offers various types of static mixers optimized for specific applications:

- Blending of miscible liquids or gases is achieved by both the continuous splitting and radial transposition of the flow. Depending on the physical properties of the fluids, the flow may be laminar, transitional or turbulent. In the presence of turbulence, mixing is enhanced by the generation and control of large scale turbulent eddies.
- Dispersions are created when the involved components are immiscible and a liquid component forms the continuous phase. The desired mean drop size and a narrow drop size distribution are achieved through uniform energy dissipation in the total mixer volume and the simultaneous distribution of the components over the entire pipe cross-section.
- A combination of mist and film flow is created when a gas forms the continuous phase of a multi-phase flow. The mixing elements can be configured to achieve a large mass transfer area and a high turbulence, resulting in intensive contact between the gas and the liquid, which is essential for gas scrubbing applications.
- In plug flow and loop reactors equipped with static mixing elements, chemical reactions can be performed under precisely controlled conditions, which is in particular relevant for highly exothermic and endothermic reactions. In addition to rapidly mixing and/or dispersing feed components, the Sulzer mixers create plug flow and greatly enhance heat transfer both within the fluid, and with contacting surfaces for temperature control.

Compact dimensions, low pressure drop

The energy needed for the mixing process in a static mixer is that required to overcome the pressure drop associated with the flow through the device. This energy is typically supplied by a pump or a blower installed in-line with the mixer. Excessive pressure drop and resulting energy cost is undesirable. Sulzer mixers are optimized for low pressure drop and compact dimensions. Their demand for energy and space is therefore small, thus having a positive impact on both operating and investment costs.

The pressure drop Δp in [Pa] of single-phase flows in different Sulzer mixer types can be roughly estimated as follows:

Laminar flow

- SMX: $\Delta p = 1150 \eta v L / D^2$
- SMX plus: $\Delta p = 570 \eta v L / D^2$
- SMXL: $\Delta p = 250 \eta v L / D^2$

Turbulent flow

- SMV: $\Delta p = 2.0 \rho v^2 L/D$
- SMV-X: $\Delta p = 1.0 \rho v^2 L/D$
- SMX plus: $\Delta p = 1.7 \rho v^2 L/D$
- SMI: $\Delta p = 2.2 \rho v^2$
- CompaX, KVM: $\Delta p = 1.4 \rho v^2$
- Contour: $\Delta p = 0.5 \rho v^2$

where v = superficial velocity in [m/s], L = mixer length in [m] without empty spaces required by the selected mixer type to achieve a specific mixing task, D = inner pipe diameter in [m], η = dynamic viscosity in [Pa s] and ρ = density in [kg/m³].

Examples of typical pressure drops:

- Flue gas (Contour): $\Delta p = 1$ mbar
- Water (CompaX): $\Delta p = 20$ mbar
- Polymer melt (SMX plus): $\Delta p = 10$ bar

This summary is intended to be a guideline only. Please contact one of our sales engineers for exact calculations, special designs and complex mixing tasks.

High degree of homogeneity with miscible fluids

Sulzer static mixers are designed to generate a homogeneous mixture in a short pipe section at low pressure drop. They have been investigated and optimized using the most advanced experimental and numerical methods to maximize performance and to make sure that the best design can be selected for the mixing task. The achieved degree of homogeneity depends on the type and number of mixing elements, the available mixing length and the product properties.

It is quantified by the coefficient of variation (CoV), which describes the averaged local deviations of a property (such as the concentration) from the mean value in a given cross-section downstream the mixer.

$$\text{CoV} = \frac{1}{\bar{x}} \sqrt{\frac{1}{n-1} \sum (x_i - \bar{x})^2}$$

Where

x_i = measured concentration,
 \bar{x} = mean concentration and
 n = number of samples.

The goal for many industrial processes is to achieve a CoV of 0.05 (5%), which guarantees a high product quality. If a sufficient number of samples are taken from such a mixture, then 95% of the samples will have a concentration which deviates less than 10% from the mean value. A higher or lesser degree of homogeneity can be achieved if required by adjusting the mixer design.

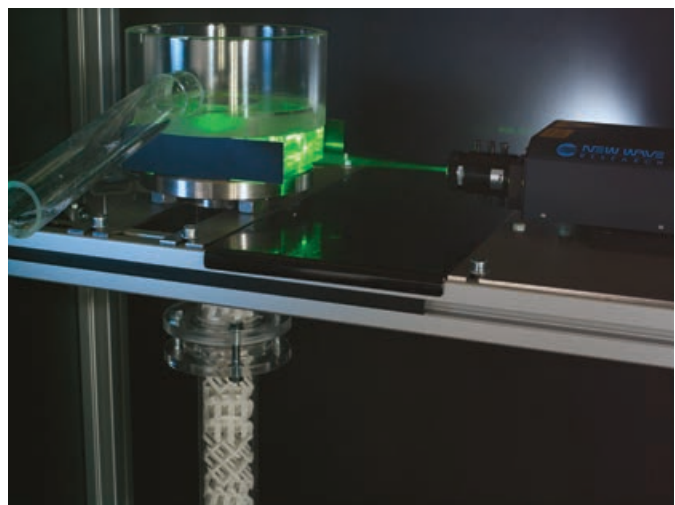

Experimental investigation of homogeneity using LIF (Laser induced fluorescence).

Properties of Sulzer Mixers

Uniform drop size

Sulzer mixers are capable of generating a dispersion with a specified mean drop or bubble size and a narrow size distribution if immiscible liquids or gases and liquids are involved (the gas has to be the dispersed phase in this case). Sulzer developed a correlation that allows the prediction of the drop or bubble size based on the specific process conditions and fluid properties. The correlation has been verified for various mixer types and a wide range of process conditions. From the calculated specific surface area of the dispersed phase, the mass transfer achieved can be estimated.

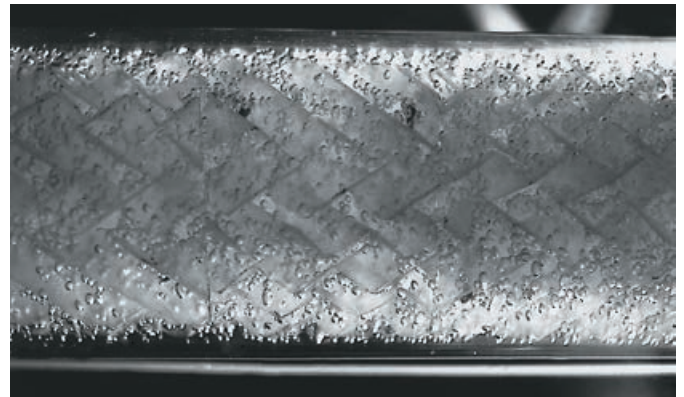

Gas-liquid dispersion generated by an SMV mixer.

Intensive heat transfer

Intensive radial mixing in static mixers evens out deviations in concentration as well as in temperature. Fluid at the core of the pipe is continuously exchanged with that at the wall. The thermal boundary layers at the wall are renewed, and this results in higher heat transfer coefficients than would be possible in a bare pipe or tube. The outcome is particularly valuable when processing high-viscosity fluids in laminar flow. The required heat transfer is achieved with small temperature differences, short residence time, and uniform shear stress—all characteristics favorable for the processing of sensitive products.

Sulzer mixing elements are applied in monotube and multitube heat exchangers. They can also be installed in loop reactors to ensure safety in even very highly exothermic chemical reactions.

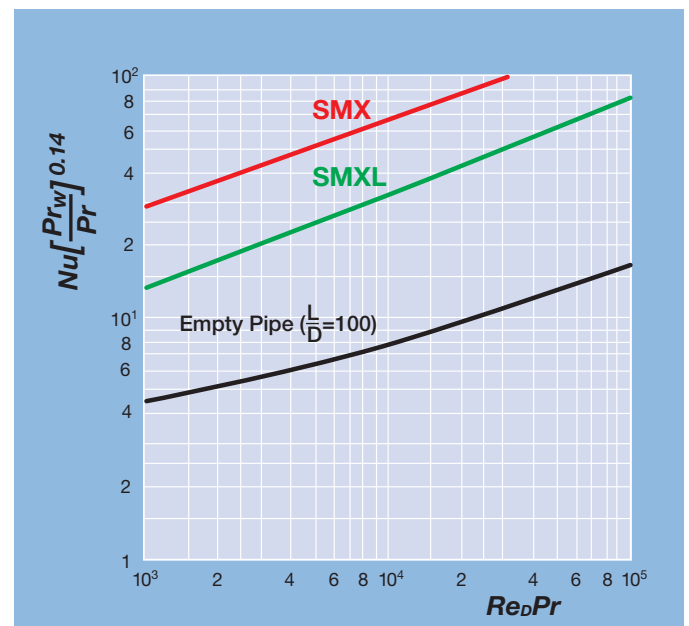

Comparison of Nu numbers in SMX mixer, SMXL mixer and empty pipe.

Narrow residence time distribution

Radial mixing in static mixers equalizes not only concentrations and temperatures, but also velocity distribution. Equal velocity means uniform residence time and little axial backmixing. Neither breakthroughs nor stagnant zones are observed. Static mixers are therefore employed as plug flow reactors. The flow regime in the reactor may be laminar or turbulent.

Example: The residence time distribution of an SMXL mixer DN 32 with a length of 1 m corresponds to a cascade of approximately 30 Ideally Stirred-Tank Reactors.

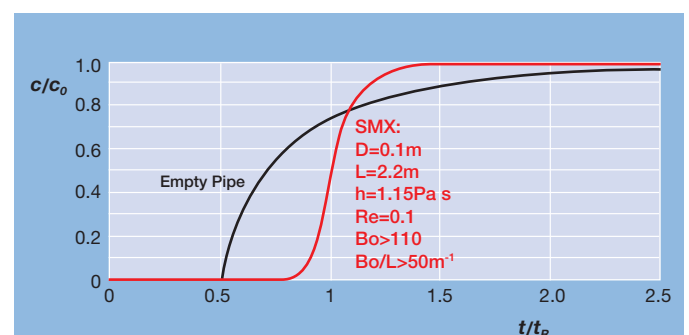

Comparison of residence time distribution of SMX mixer and empty pipe.

Product Portfolio

SMV

The SMV mixer is made of corrugated plates that form open, intersecting channels in which the flow is divided into many substreams. The SMV mixer is used in the turbulent and transitional flow regime, in particular, to intensify mass transfer between immiscible fluids. The SMV structure is extremely adaptable. The energy input and internal surface area can be optimized to meet the specific requirements of the application. Mixing elements can be built for round, square, rectangular, and even conical and ring-shaped pipes and ducts. They are available in various materials, including plastics such as PP, PVDF, and PTFE.



SMV mixer applied for mixing of ethyl benzene and steam in a styrene production plant

SMI™/KVM™

The Sulzer mixer types SMI and KVM are vortex mixers, which are designed for fully turbulent flow. Typically, these are made up of two mixing elements configured with an empty pipe section between them. Each mixing element is designed to create two large counter-rotating eddies, which provide intensive mixing with very low pressure drop.



SMI and KVM mixer

The SMI mixer has a pair of inclined winglets attached to the pipe wall. The KVM mixer has blades in the center of the pipe. Both structures are extremely open, which eliminates any risk of clogging. SMI and KVM mixers are available in a broad selection of metals; stainless and carbon steels are commonly used.

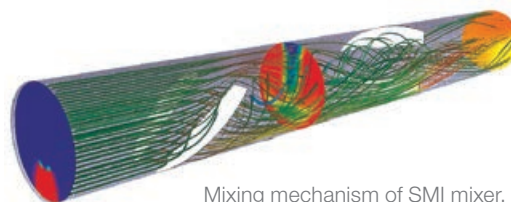

Mixing mechanism of SMI mixer.

CompaX™

The Sulzer CompaX mixer, like the SMI and KVM, is designed for fully turbulent flow. It is especially suitable to mixing small amounts of additive into a bulk flow within a very short mixing length. The CompaX mixer has a single mixing element integrated into a short ring or flanged housing, which is installed between two flanges of a pipeline. The additive is injected through the integrated feeding device into a highly turbulent zone behind the central blade of the mixer, where it is immediately diluted. Further downstream, it is distributed over the entire cross-section by the two large counter-rotating eddies that are produced by the mixing element. Good mixing quality is achieved only three pipe diameters downstream. CompaX mixers are available in stainless steel and various plastic materials, such as PP and FRP. PTFE coated stainless steel is also available.

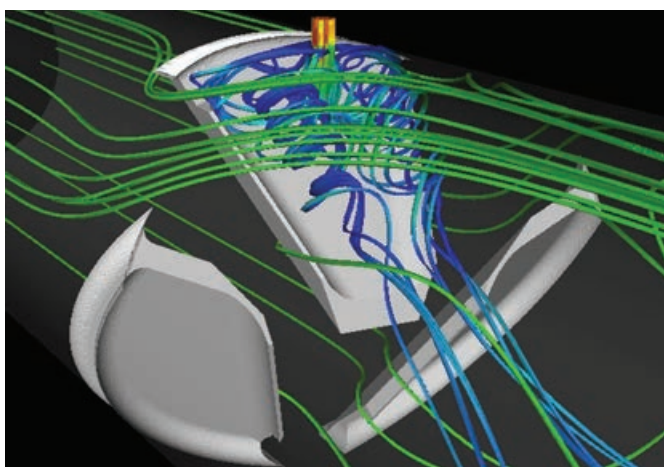

CFD simulation showing the mixing mechanism of the CompaX mixer

Product Portfolio

Contour™

The Sulzer Contour mixer is designed for the installation in large rectangular flue gas ducts. The mixer consists of a set of pairs of short wings. Each pair of wings generates a large-scale vortex downstream without any flow detachment. This equalizes concentration deviations in the duct very quickly at extremely low pressure drop. Co-rotating or counter-rotating vortices can be generated depending on the mixing task. The wings of the Contour mixer are very lightweight. They can be easily installed using simple wall adapters in new or existing ducts of any shape.

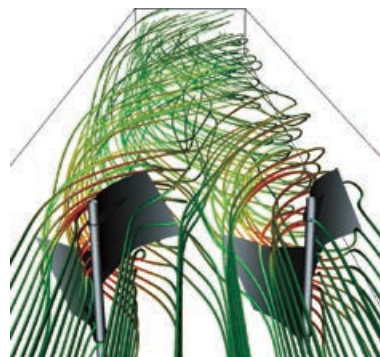

SMV mixer applied for mixing of ethyl benzene and steam in a styrene production plant

SMX™/SMX plus™

The Sulzer SMX mixer has been the industry standard for demanding mixing applications – especially in the laminar flow regime – for more than 30 years. The SMX mixer has a grid of inclined bars, which repeatedly divide the components into layers and spread them over the entire cross-section of the pipe. Very large flow ratios, extremely large viscosity ratios, and complex rheological product behaviors can be handled effectively within short mixing lengths.

The new SMX plus mixer applies the same effective mixing principle, but it is significantly more energy-efficient. Compared with an SMX mixer of equal size, it reduces the pressure drop by 50% while achieving the same mixing result. Alternatively, the mixer diameter can be reduced for a given allowed pressure drop. The SMX plus mixer is also an attractive option for turbulent flow, especially when there are differences in component viscosity.



SMX plus mixing elements installed in a flanged housing

SMXL™

Sulzer SMXL mixer is a low intensity design applied whenever a continuous mixing action over a relatively long pipe section is required with low pressure drop. Typical application is heat transfer enhancement when installed as internals in mono-tube and multi-tube heat exchangers and plug flow reactors. Proprietary manufacturing methods enable production of long lengths at low cost relative to other designs.



Multi-tube heat exchanger equipped with SMXL mixing elements.

SMR

Sulzer SMR mixer reactor is built with mixing elements made from bent tubes. These allow heat transfer fluids to flow through the structure, thus creating a mixing element with temperature-controlled surfaces. The mixing elements provide a very high specific heat transfer area, intensive radial mixing, and a narrow residence time distribution. The SMR mixer reactor is the ideal equipment for the execution of even very highly exothermic reactions, such as polymerizations. As a heat exchanger, it is applied mostly in cooling where fluid viscosity is increasing as temperature is reduced.

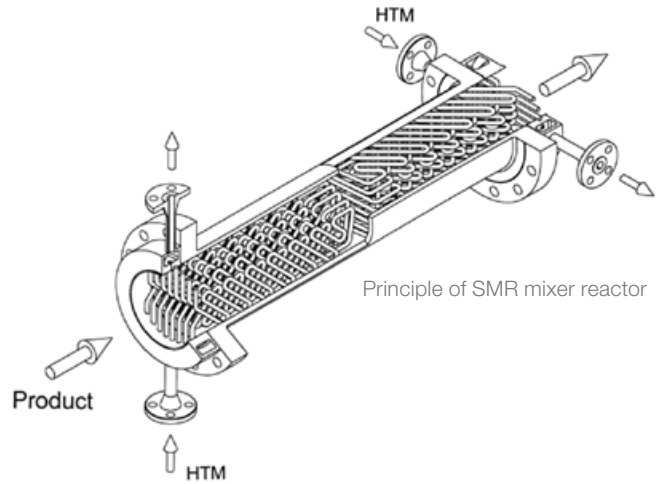

Selection of Static Mixers

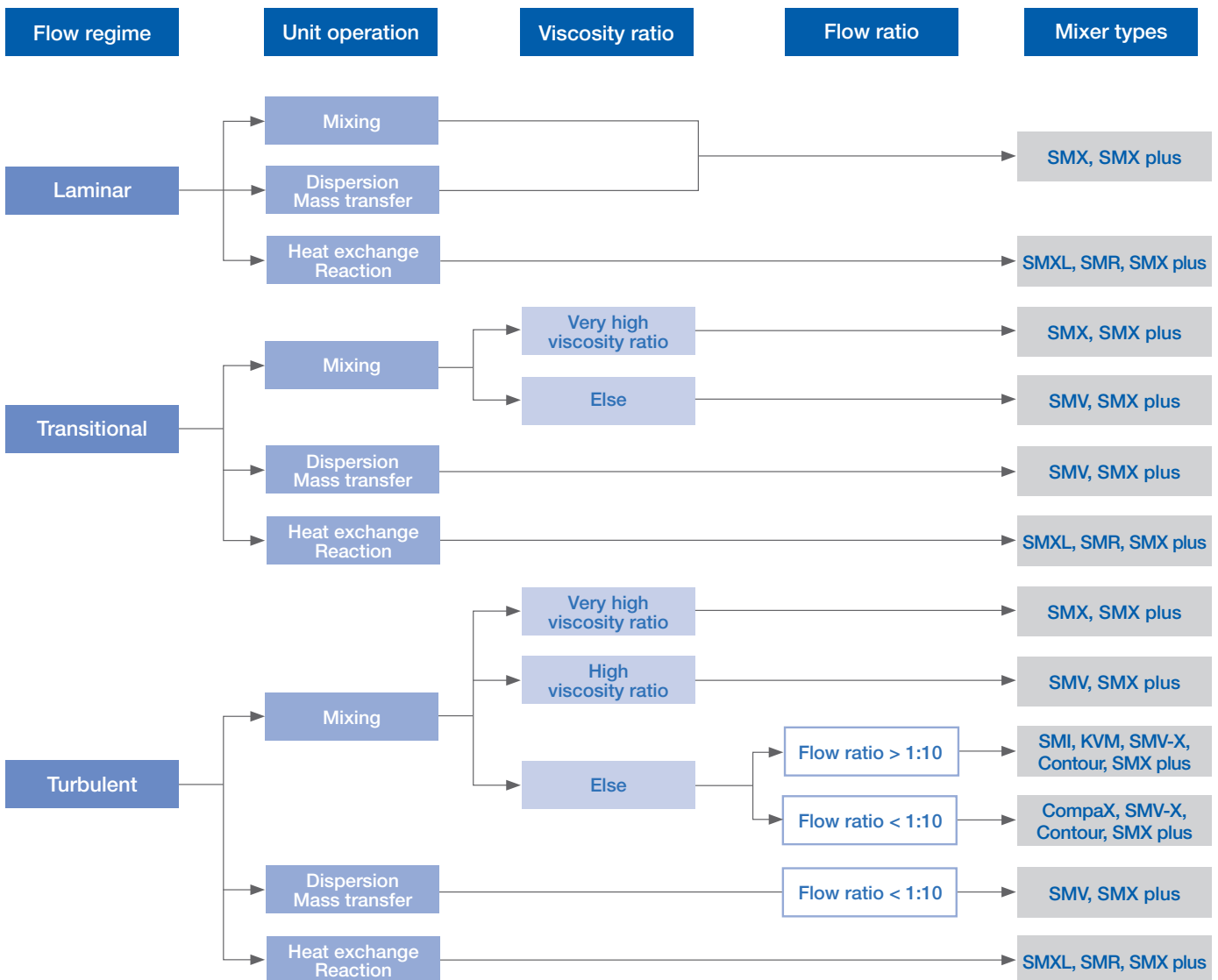

Solid Application Expertise

Sulzer mixers have been performing successfully in the petroleum industry for many years. They are employed where different liquid or gaseous media have to be thoroughly mixed or intensively contacted.

Many years of experience and continuous development in static mixing technology have enabled Sulzer to offer economic, practical solutions to a wide range of mixing problems. When using Sulzer mixers, oil refineries and gas plants can avoid or reduce some widely recognized corrosion problems.

Some examples of applications are:

- Crude oil sampling for representative determination of the water content according to the ISO 3171 code
- Overhead desalting after the atmospheric distillation column for dissolving salts into injected wash water
- Blending natural gas streams with steam, propane, or other gases
- Adjusting the viscosity of heavy oil with gas oil
- Adjusting the calorific value of natural gases
- Adjusting the sulfur content of heavy oil by mixing fractions that have different sulfur contents
- Mixing of air and process gas in SUPERCLAUS® units
- Contacting multiphase mixtures
- Saturating hydrocarbons with hydrogen before they enter the catalytic reactor bed in hydroprocessing units
- Desulfurizing distillates in Merox process units
- Treatment of service and wastewater
- Admixing of aids into water during tertiary crude oil extraction
- Seawater deoxygenation
- Mixing of bitumen or heavy crude oils
- Homogenizing solvent and feedstock in deasphalting units
- Producing bioethanol and biodiesel, which requires static in-line mixing for many process steps



Oil and Gas

Gas Dehydration with TEG

Sulzer co-current MIXDRY static mixers offer an attractive alternative to typical counter-current contactors where natural gas has to be dehydrated. Dehydration is performed by intensively contacting the wet gas with lean glycol (mainly TEG) within the compact MIXDRY system. There, high interfacial surface area is provided, which promotes the desired mass transfer. One single stage of removal can be achieved in a single mixer. Multiple stages of removal are available using multiple mixers with separators between the mixers

Customer Benefits

- Dew point reductions up to 40°C possible
- Simple installation
- Low weight and small footprint
- Low investment costs

LNG Desuperheating

Sulzer Chemtech has developed a new injection-mixing device for LNG desuperheating. With this device, LNG is injected, atomized, and intensively contacted with the gas phase (NG or BOG). This novel mixing system enhances and speeds up the evaporation through greater turbulence, higher residence time of the liquid, and a large exchange surface area. It is a direct-contact, high-efficiency evaporator as opposed to an in-line spray system, for example.

Customer Benefits

- Typically complete evaporation of the liquid LNG
- Cold spots are avoided enhancing overall evaporation efficiency
- More representative temperature measurement for liquid load control
- Reduction of liquid consumption resulting in savings on liquid pumping energy
- Proven technology

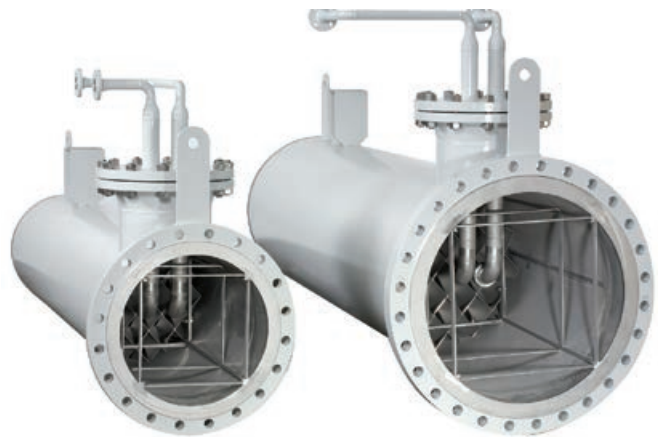

Oil and Gas

BOG Recondensing

Recondensers are used in LNG receiving terminals to recondense LNG boil-off gas (BOG) using subcooled LNG. This technique reduces the operating cost associated with the pressurization of the BOG to pipeline pressure level. With Sulzer's mixing and contacting technology, the BOG enters the mixing section in the tube with high speed, and an intense mixing process occurs. The process is reinforced by the installed mixing elements and results in more-efficient condensation than in the conventional packed bed columns design.

Customer Benefits

- Efficient condensation at pressure drops in the range of 0.3–0.5 bar
- Compact design, i.e. small volume compared to conventional packed-column type of recondensers – typically 5 times smaller in size
- Smooth operating conditions and self-regulating behaviour

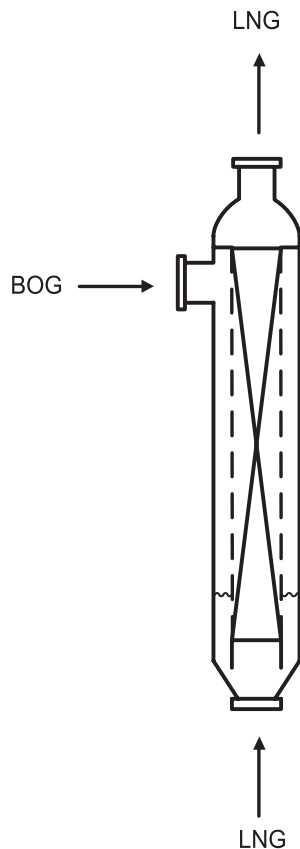

Crude Oil Desalting

Effective crude desalting is reached by first optimizing the crude/wash water contacting for the dissolution of the salt, followed by an effective separation of the two phases to avoid water carry-over in the crude.

Sulzer Chemtech is a supplier of specially configured SMV-type crude/wash water dispersers to enable intensive contacting of the two immiscible liquids so that a swarm of water droplets is formed. A homogenous distribution of these droplets is created in the crude oil, as is a large, continuously renewed interfacial area. These accelerate mass transfer.

Customer Benefits

- Predictable drop size and narrow drop size distribution preventing undesirable emulsification and allowing safe dimensioning of the settler
- Reduction of carry-over and under-carry phenomena resulting in lower reprocessing costs of about 2000 EUR per day
- Maximized interfacial surface area for optimal mass transfer
- High turn-down capacity
- At least 0.5 bar less pressure drop than mixing valve resulting in significant cost savings

CCR Reformer

During the regeneration of catalyst reactors, the regeneration gas has to be intensively contacted with a caustic water stream before entering the loop trim cooler.

A gas-liquid contacting system consisting of a Sulzer mixer installed after a liquid distribution nozzle generates a flow of fine droplets. The flow provides a large interfacial surface area for most-intensive contacting.

Customer Benefits

- Flexible wash efficiency through liquid load changes
- Pressure drop smaller than 0.1 bar giving low energy requirement
- Experience in providing special arrangement designs made of high alloy steels



Gas Treating

The Sulzer SMV co-current gas scrubber is often installed for process gas treatment in refineries to remove impurities from a gas. During the process, the gas is contacted with a scrubbing liquid to promote the desired mass transfer from the gas to the liquid phase. Typical refinery gas washing removes sulphur compounds like H₂S, COS, and SO₂, acids like HCl and HF, and many salts. Gas washing systems with Sulzer SMV mixers give highest removal rates.

Customer Benefits

- Small equipment volume resulting from high permissible gas velocities
- Optimum results using chemical absorption process
- Pressure drop usually between 0.1 and 0.5 bar giving low energy requirement



Oil and Gas

Sulphuric Acid Alkylation Unit

The sulphuric acid alkylation process from DuPont Stratco calls for specially configured Sulzer SMV™ mixers and dispersers. The caustic wash mixers are designed to comply with the requirements of the downstream settler, and to fully neutralize acid components. The neutralization is of great importance for the downstream process. The separation columns located after the separators are corrosion protected by the static mixer efficiency. Bad designed mixers result in great corrosion problems in the columns.

Customer Benefits

- The SMV configuration can be attuned to the pressure drop and drop size as well as drop distribution expectations
- Low acid and caustic carry over protect downstream columns
- Acid wash and product-neutralizing SMV Static Mixers improve plant overall efficiency



Hydrocracking Unit

Vapor effluent flashed off from the high-pressure (HP) hydrocracker reactor is mixed with wash water to dissolve ammonium bisulfides (NH₄HS) upstream of the HHP off-gas cooler.

The water wash prevents salt deposit buildup on the cooler tubes and the associated increased corrosion rates. Using a specially configured SMV mixer installed after the spraying nozzles gives the best washing efficiencies in the process stream (HHPs vapor).

Customer Benefits

- Higher run length of the unit
- Less salt deposits (NH₄HS) in the cooler
- Reduced maintenance work allowing operational reliability
- Pressure drop usually between 0.3 and 0.5 bar giving low energy requirement
- Proven technology specified by process licensor with more than 100 references



Chemical / Petrochemical Industry

Thousands of references document the versatility of Sulzer mixers in the chemical process industry. The applications include: mixing liquids at various viscosities, mixing including reactions, gas-liquid contacting, mass transfer and absorption, gas mixing, and liquid evaporation as well as heat removal in exothermal reactions.

The mixers are available in a wide range of materials, which allows users to handle even corrosive chemicals effectively.

Applications

- Diluting of strong acids and bases
- Adding additives, catalysts and inhibitors to process streams
- Mixing of different liquid streams to attain uniformity of concentration and temperature
- Dispersing of alkali in hydrocarbons

Gas Phase Reactions

To attain high selectivity and a high yield in catalytic gas phase reactions, uniform concentration and temperature distributions plus a flat velocity profile at the reactor inlet are essential. Sulzer mixers are used upstream of reactors to attain continuous mixing of additives and conditioning of the inlet gases. As a result, catalyst life is extended considerably in plants.

Applications

- Production of monomers, as Styrene Monomer
- Production of organic acids
- Production of anhydrides

Customer Benefits

- Uniform concentration and temperature distribution
- Low pressure drop
- Longer catalyst lifetime



Chemical/Petrochemical Industry

Gas liquid contacting and absorption

Sulzer dispersers are used for considerably different operations as physical or chemical absorption of gases into liquids, mass transfer for homogeneous or heterogeneous chemical or biochemical reactions, stripping gases from liquids with a stripping agent.

Applications

- Production of Ethylbenzene
- Production Dichlorethylene
- Hydrogenation of aromatics

Customer Benefits

- Uniform droplets range
- High mass transfer area

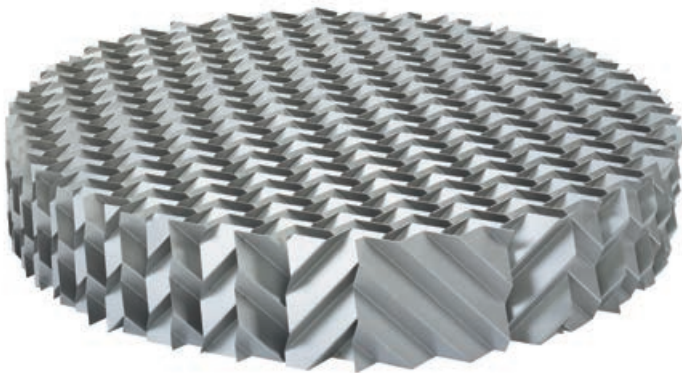

Heat exchange in exothermic reactions

The Sulzer SMR mixer-reactor is well suited for the performance of continuous temperature-controlled chemical reactions since mixing and heat transfer occur simultaneously. There are different modes of operation:

- with once-through product flow (plug-flow system)
- with recycled product flow (loop system)
- combination of loop and plug-flow system

Applications

- Alkylation reactions
- Sulphonation reactions
- Switching batch to continuous process for constant product quality and smaller reactor volumes

Customer Benefits

- High heat transfer capacities
- Uniform temperature profile
- Low pressure drop

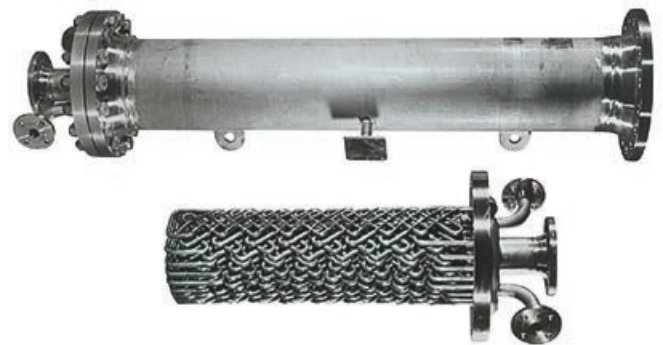

Chemicals

Homogeneous and disperse plug flow reactors reactions

With the various Sulzer mixing elements, it is possible to have reactions within a narrow residence time distribution and with a maximum possible driving force.

The plug flow behavior can be achieved in a laminar flow regime as well as in a homogeneous and dispersed phase.



Further examples of applications

- Optimized gas/liquid distribution at the inlet of two-phase reactors to improve the efficiency of the reactor
- Liquid/liquid dispersion for extraction reactions
- Plug flow reactor for homogenous or dispersed-liquids systems

Customer Benefits

- Excellent mixing and flow characteristics (plug flow) with low shear
- Narrow residence time distribution
- Excellent in-line cleaning and sterilization ability
- Fewer wall effects prevent overheating
- High selectivity for desired product
- Modular design for flexible operation
- Scale-up correlations well established

Solid Application Expertise

Mixing in large gas ducts

Static mixers are often used in the flue gas treatment systems of thermal power stations, cement works, refineries, steam reformers, steelworks and so on. They are used to homogenize the gas temperature or the concentrations of components of the gas stream, to admix small amounts of additives for chemical processes such as the reactions taking place in the selective catalytic reduction (SCR) process, or to homogenize or distribute the dust or ash in the flue gas. These mixing tasks are often crucial for the effectiveness of the whole flue gas treatment process.

The static mixers from Sulzer Chemtech are high-fidelity solutions that have been optimized for extremely low pressure drops and very efficient mixing over short mixing lengths. Our offering for such applications, the Sulzer Contour Mixer, leads the industry in terms of its excellent mixing performance at an unrivalled pressure drop. In addition, the classical Sulzer SMV mixer offers outstanding performance and is still regarded as the standard solution for such applications by many of our customers.

For DeNOx applications with SCR reactors, our solution for admixing the NH₃ to the flue gas for a NO_x conversion of >90% and < 2ppm NH₃ slip typically generates less than a 1 mbar pressure drop. If even higher conversion rates are required, our bespoke mixer solutions can help achieve outstanding performance.

The static mixers from Sulzer Chemtech work equally well at a wide range of loads. This is very important for units that experience frequent changes in load. Typically, the incoming profiles of temperature, NO_x, and dust can vary significantly, depending on the load case and the fuel used in the boiler. With a Sulzer static mixer solution, such changes in the operational conditions will not cause significant changes in the overall performance of the flue gas treatment system.

Optionally, the equipment can be thermally coated with an extra hard skin. This coating increases the equipment's resistance in situations with flue gas that contains highly erosive dust, and it significantly reduces damage to the equipment.



Installation of Sulzer Contour™ mixers in a large gas duct

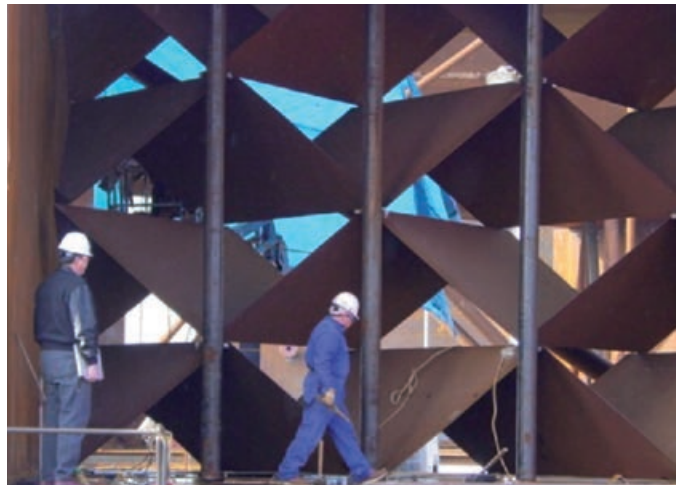

Installation of a Sulzer SMV™ mixer with Ammonia Injection Grid

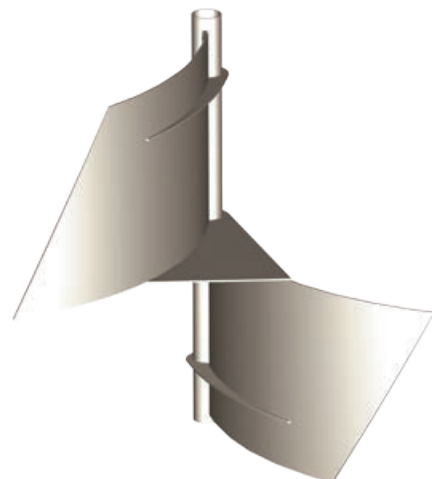

Sulzer Contour™ mixer wing pair for static mixing tasks in flue gas applications

Energy

In order that the mixer can work properly and the pressure loss remains low, the flow in the whole flue gas duct needs to be analyzed and optimized. This is why Sulzer Chemtech always makes use of CFD during the design of mixing systems for large scale flue gas ducts. The whole package of duct, guide vanes, turning vanes, dampers, dosing grids, static mixers and rectifiers need to work together in an optimal way to achieve the desired system performance. Therefore all these components are included in the CFD analysis.

Many customers require an additional experimental verification of the whole solution in scaled down cold flow experiments. Sulzer Chemtech is both ready to take responsibility for such physical model tests or to cooperate with its customer to perform these tests elsewhere.

Sulzer Chemtech not only manufactures the dosing grids and static mixers, it is also a valuable partner for the design of the whole set of duct internals and it is ready to take guarantees for the performance of the solutions developed.

Depending on the quality of the coal fired in the boiler, the dust contained in the flue gas can have highly erosive properties, which can lead to quick degradation of the SCR catalyst. This is particularly true for lignite or brown coal. Sulzer static mixers can be designed to distribute the dust in the flue gas uniformly in order to avoid localized peaks in erosion of the catalyst.

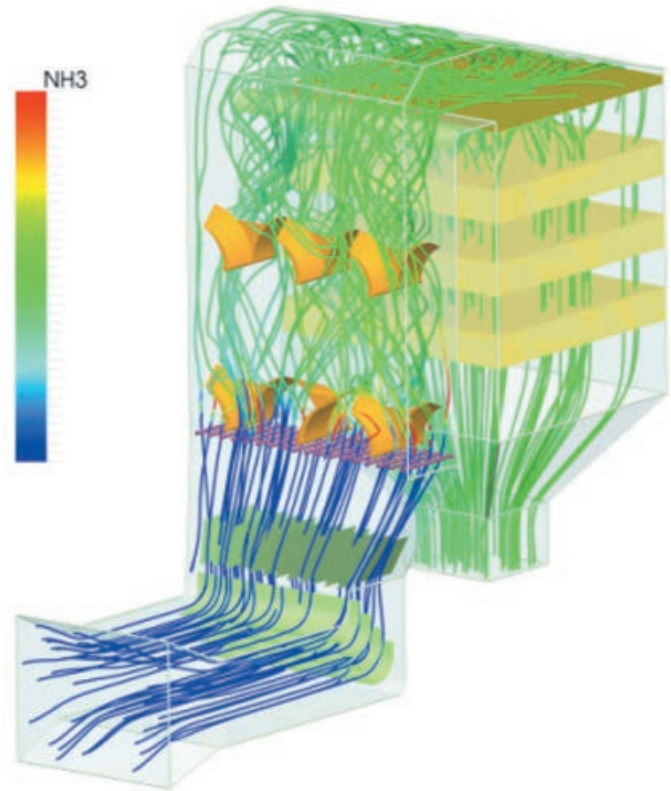

Streamlines through gas duct with AIG, Sulzer Contour mixers and SCR catalyst, colored by local NH₃ concentration

Customer Benefits

- Well proven, highly efficient dosing and static mixing equipment
- Solution with lowest pressure drop on the market
- Customer support through extensive CFD analysis during design phase
- Optional erosion protection coating
- Static mixers for catalyst erosion protection

Water

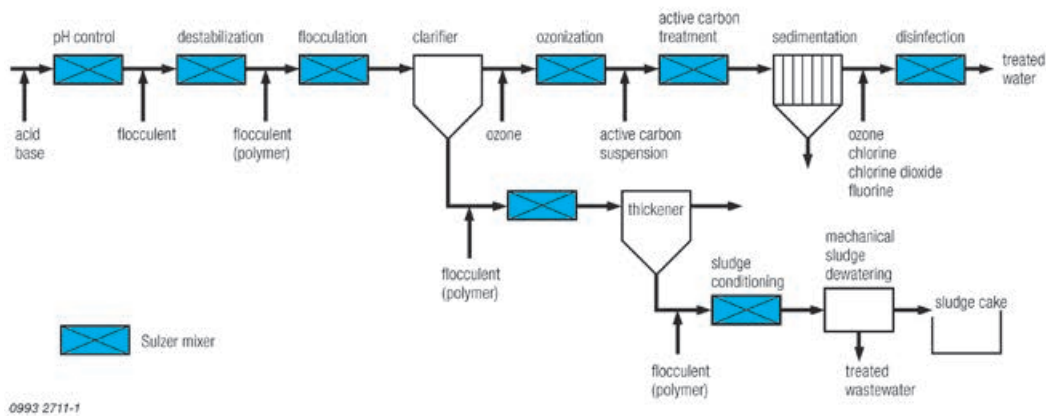

Figure 1. CompaX static mixer with purple additives. Complete mixing at about 3D downstream of static mixer.



Figure 2. Sulzer Ozonation Mixer



Figure 3. FRP material

Function

A static mixer consists of a sequence of stationary guide plates. When media is pumped through the mixer, the plates achieve the systematic, radial mixing of media flowing through the pipe. The flow path follows a geometrical pattern, precluding any random mixing. The mixing operation is therefore completed within a very short flow distance.

In gas/liquid contacting, e.g., in ozonation, the formation of fine gas bubbles in a water/gas mixture promotes intensive contact between the two phases. The result is high mass transfer—for instance, a high oxygen transfer rate or an excellent ozone utilization factor.

In contrast to stirred tanks or empty pipe systems, static mixers ensure that the complete fluid stream is subjected to compulsory or enforced mixing or contacting. The energy required for mixing or for mass transfer is taken from the main stream itself, which is manifested by an insignificant pressure drop than in an empty pipe system. This value depends on the design of the mixer and on the relative operating conditions. It is generally in the range of 5-300mbar.

The energy requirements of static mixers is at least an order of magnitude smaller than that of dynamic agitator systems. In addition, the energy is evenly dissipated throughout the entire mixer volume.

Customer Benefits

- Continuous process
- Short installation length
- Low pressure drop
- High mixing efficiency = less chemical used
- Clogging free
- Independent of mixing ratio
- Wide size range from as small as DN15 to DN2200
- Multiple dosing possible
- Wide range of material available, See Figure 3 and 4
- Installations in rectangular ducts possible

Wider Application Fields – Other Markets

While static mixing was initially an alternative to batch processing with agitators in tanks, the role of the technology in the continuous production of all types of fluids in many industries has increased in importance. The main business drivers are:

- high-quality products
- high production yield
- reproducible product quality
- cost-effectiveness
- a solution with minimum space requirements
- energy efficiency
- rapid line transition capability with minimum waste

High efficiency static mixer designs from Sulzer have enabled industry to meet these goals. Mixing and Dispersion to meet specific process/product requirements are routine with application across the full range of flow conditions in the laminar, transition and turbulent flow regimes. Additionally, Sulzer designs are applied to enhance heat transfer and establish plug flow in single pass and loop reactors.

The technology is available in a broad selection of materials of construction. Equipment is designed to meet industrial requirements for chemical, sanitary and hygienic service.

Food and Beverage Industry

- Blending flavor, color, nutritional supplements and other ingredients with base products in the production of soups, cereal, yogurt, chocolate and concentrates
- Bulk product dilution – Sugars, syrups and juice
- Heat Exchange
 - Heating and Cooling chocolate for tempering
 - Cooling after grinding
 - Devolatilization of syrups for coating
- Dispersion of Gases into liquids
 - Carbonization of beer
 - Aeration to lower bulk density
- Dissolving solids after induction into a bulk stream

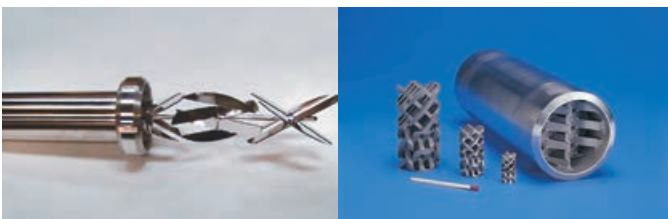

Customer Benefits

- Clean, in-place design features
- Cost effective, compact and energy efficient

Personal Care Products

- Mixing and dispersion in high volume continuous production processes
 - Feed stocks, emulsifiers, surfactants with water and oils
- Admixing proprietary ingredients to achieve product identity qualities, e.g., color, texture, and scent, etc.
 - In the production of detergents, fabric softeners and household cleaners
 - In the production of tooth paste, deodorant, shampoo and body lotions
- Composition and temperature homogenization
 - Filling speed and uniformity in high speed packaging
- Heat Exchange
 - Cooling in processing loops and prior to packaging
 - Heating viscous feed stocks between storage and processing
 - Maintaining temperature to control viscosity

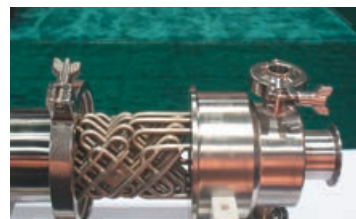

Customer Benefits

- Predictable performance, constant over time
- Reliable scale-up
- Turndown capability

Wider Application Fields – Other Markets

Reactive Resins, Adhesives, Sealants, Paint and Coatings

- Mixing and dissolution of blowing agents
 - Foamed insulation, sheet and shapes
- Mixing fillers and additives with base product
 - Mixing and distribution of cross linking agents in base fluid
 - addition of color, UV stabilizer and fire retardant
- Two part component mixing
 - Equal parts and viscosity (disposable mixer market)
 - With high flow and viscosity ratios
- Heat Exchange
 - Cooling in high energy dissipation process loops
 - Post reactor cooling prior to packaging
 - Heating and cooling on roll coating lines
 - Devolatilization to remove solvents and excess monomers

Customer Benefits

- Mixing intensity to meet process requirements
- High degree of color or additive uniformity
- Temperature control for process and packaging

Pharmaceutical and Biotech

- Rapid Mixing
 - For fast reactions – high selectivity with parallel and sequential reactions
 - To initiate precipitation – continuous crystallization processes
 - Salt base dilution
- Plug flow reactors – meeting uniform residence time requirements
 - Hydrolysis
 - Dissolving crystals
 - Expanded fluidized bed processes
- High intensity dispersion
 - Oil-water dispersions to create microspheres of controlled diameter
 - Purification of products, extraction of contaminants
- Heat exchange with plug flow
 - Temperature control – heating and cooling with single and multiphase fluids
 - Control of exotherms
- High surface mixer substrates for cell growth

Customer Benefits

- Sanitary design, kilolab to commercial scale
- Precise temperature control
- Plug flow characteristics
- Mixing and dispersion to meet specific process requirements



Comprehensive Engineering Services Markets

Development and Technology

Sulzer makes every effort to support our customers and continuously improve our design tools. Engineers in the R&D lab develop new and improved products, analyze and optimize processes.

We maintain close relationships to universities and independent research organizations to support these efforts.

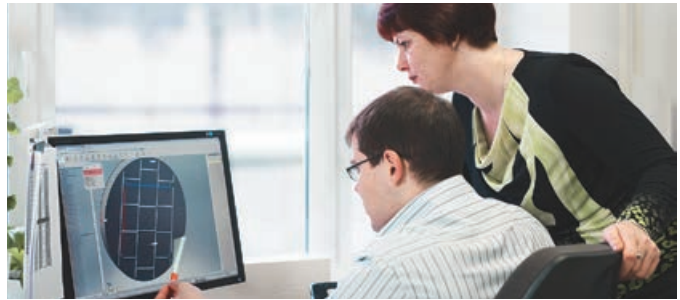

Engineering and Manufacturing

Sulzer has a long-standing manufacturing tradition. Sulzer owns dedicated factories in every region to produce mixers, columns, reactors, and heat exchangers.

For certain sizes and certain countries, we work with well-known and proven subcontractors who are bound by Sulzer manufacturing policies and quality standards.



- Global Headquarter: Singapore
- Manufacturing/Service Centre
- Sales offices

Capabilities

Manufacturing according to PED 97/23/EC, ASME VIII Div.1, and ASME B31.3/U-Stamp, Gost (TR), China Stamp, Norsok, or NACE

Design codes acc. to AD2000, EN 13445, ASME Broad selection of material for construction available

Non-destructive testing (LPT, X-ray, pressure testing up to 500 bar, PMI, MT, UT etc. acc. EN and ASME)

Designing with SolidWorks

Strength calculations, FEM analysis, nozzle loads etc.

Certification for ISO 9001, ISO 14001 and ISO 18001

Experienced project management team

CFD Analysis

CFD calculations done in advance of fabrication can support the decision to go for a particular technology, and can save on the time required for commissioning and testing later. Sulzer uses CFD technology both for the modeling of existing and the development of new products.

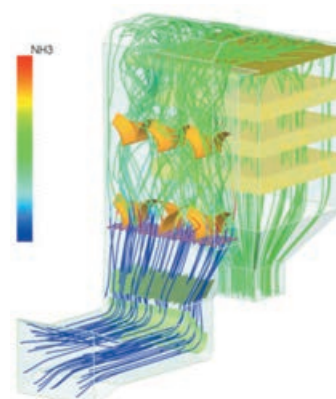

www.sulzer.com

Please check for your local contact

Sulzer Chemtech Ltd, a member of the Sulzer Corporation, with headquarters in Winterthur, Switzerland, is active in the field of process engineering and employs some 4000 persons worldwide.

Sulzer Chemtech is represented in all important industrial countries and sets standards in the field of mass transfer and static mixing with its advanced and economical solutions.

The activity program comprises:

- Process components such as fractionation trays, structured and random packings, liquid and gas distributors, gas-liquid separators, and internals for separation columns
- Engineering services for separation and reaction technology such as conceptual process design, feasibilities studies, plant optimizations including process validation in the test center
- Recovery of virtually any solvents used by the pharmaceutical and chemical industry, or difficult separations requiring the combination of special technologies, such as thin film/short-path evaporation, distillation under high vacuum, liquid-liquid extraction, membrane technology or crystallization.
- Complete separation process plants, in particular modular plants (skids)
- Advanced polymerization technology for the production of PLA and EPS
- Tower field services performing tray and packing installation, tower maintenance, welding, and plant turnaround projects
- Mixing and reaction technology with static mixers
- Cartridge-based metering, mixing and dispensing systems, and disposable mixers for reactive multi-component material

Distributed by:

