

Troubleshooting with Service Data Kit

Information of how pump run data is stored in AquaTronic and can be used in service checks and trouble shooting.

 **DANGER!** Always check that the pump is disconnected from the electric power supply before connecting it to the computer.

AquaTronic communication cable with standard USB contact

PC with Windows XP or later

Adobe Reader

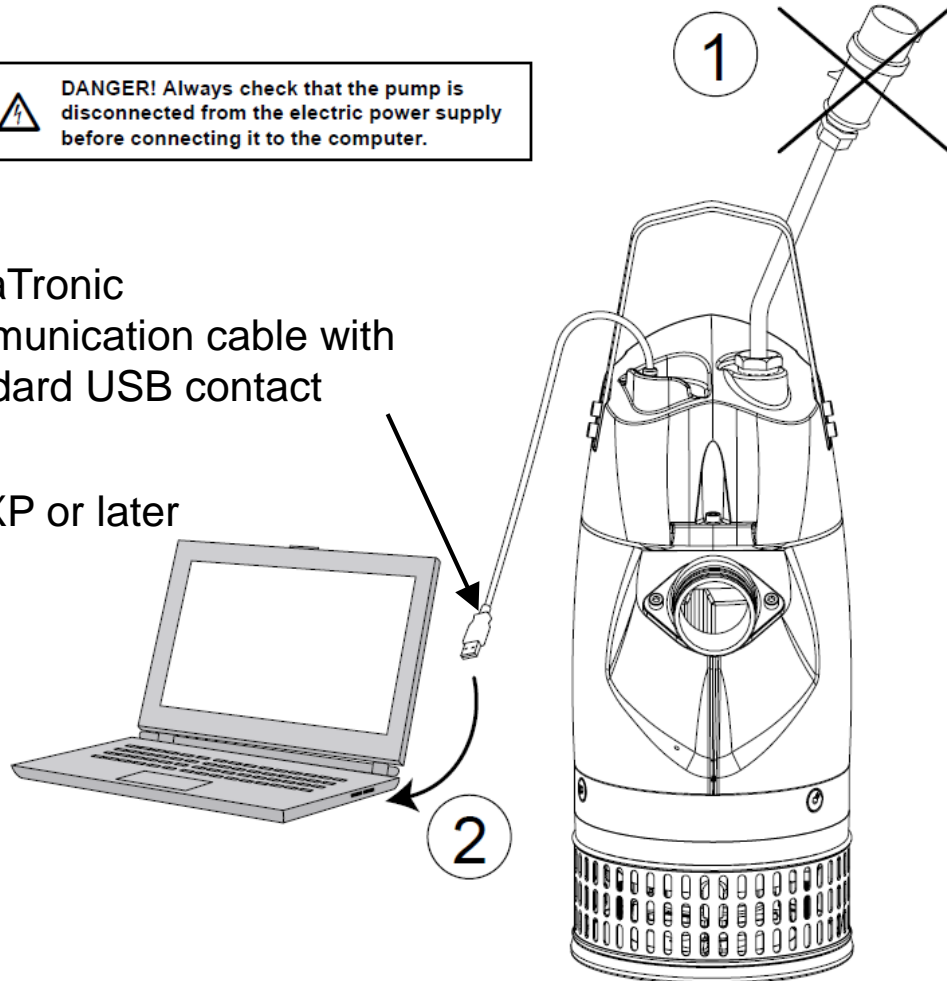

Troubleshooting with Service Data Kit

This information contains two parts.

The first is describing how the AquaTronic device is working and how you can make readouts from the device with XJ Service data kit. (pages 1-17)

The second is showing how possible faults on XJ submersible dewatering pumps can show in XJ service data kit readouts. (pages 18-44)

Start of Service Diagnostic Software

The screenshot shows a Windows Explorer window titled "Removable Disk (G:)" with a menu bar (File, Edit, View, Favorites, Tools, Help) and a toolbar (Back, Forward, Up, Search, Folders). The address bar shows "G:\". The main pane displays a list of files and folders:

Name	Size	Type	Date Modified
Aqualog		File Folder	2012-06-27 13:11
PUMPINFO		File Folder	2012-06-27 13:10
AQUATRON.ICO	4 KB	Icon	2006-06-06 06:06
AquaTronic.exe	2 319 KB	Application	2012-02-28 11:37
PROGRAM.TXT	1 KB	Text Document	2006-06-06 06:06

On the left, there are sections for "File and Folder Tasks" (Make a new folder, Publish this folder to the Web, Share this folder) and "Other Places" (My Computer, My Documents, My Network Places). A callout box with an arrow pointing to "AquaTronic.exe" contains the following text:

When connecting computer with pump through USB interface this box shall pop up. Double click on icon AquaTronic.exe to start program.

At the bottom of the screenshot, another callout box contains the following text:

If this box do not show when connecting pump with the USB cable, use your Explorer to find pump memory.

First view of AquaTronic display

Tab 2 - Name plate data and firmware version

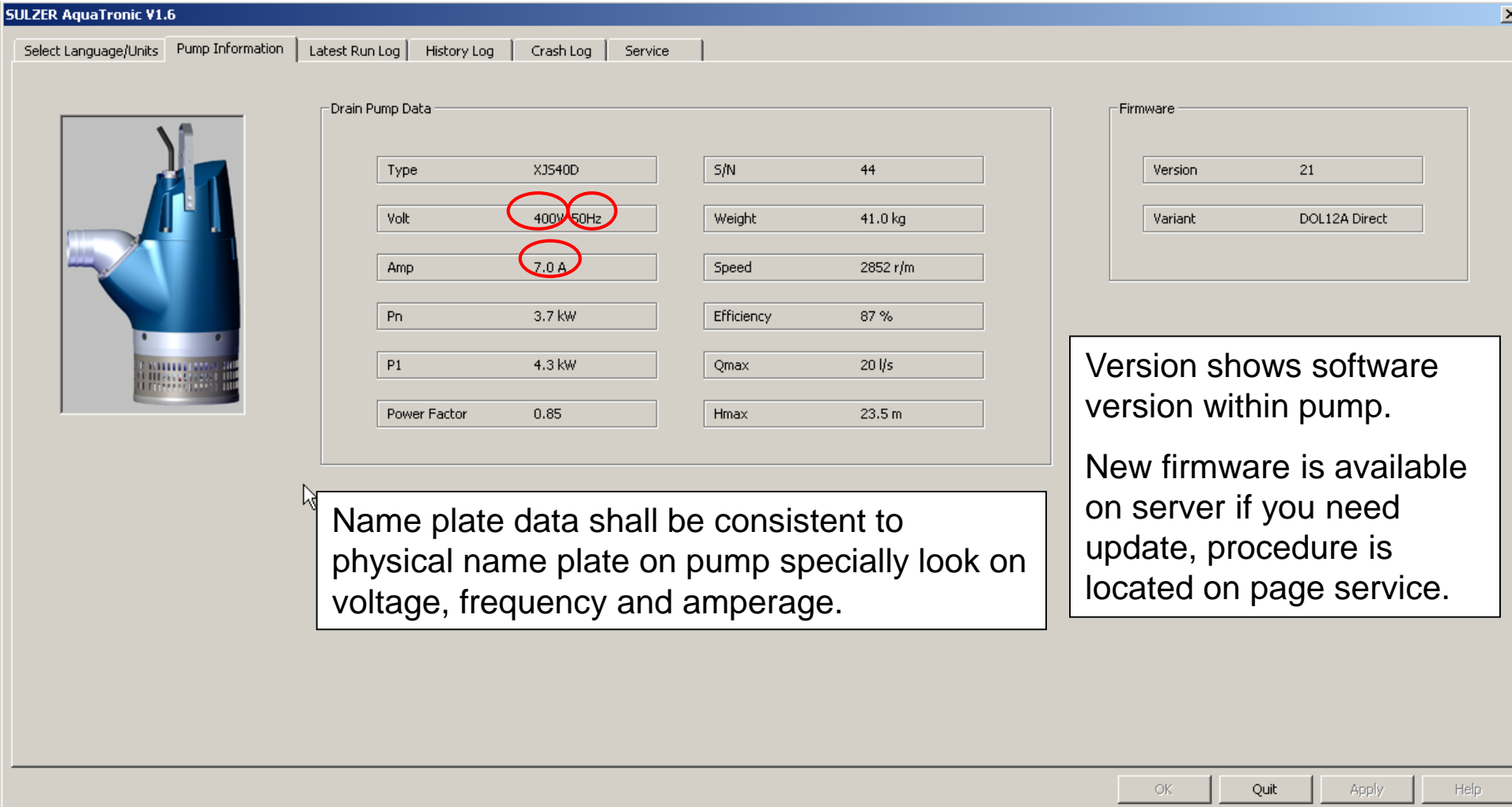

The screenshot displays the 'SULZER AquaTronic V1.6' software interface. The top navigation bar includes 'Select Language/Units', 'Pump Information', 'Latest Run Log', 'History Log', 'Crash Log', and 'Service'. The 'Pump Information' tab is active, showing a 3D model of the pump on the left and two data panels on the right.

Drain Pump Data

Type	XJS40D	S/N	44
Volt	400V 50Hz	Weight	41.0 kg
Amp	7.0 A	Speed	2852 r/m
Pn	3.7 kW	Efficiency	87 %
P1	4.3 kW	Qmax	20 l/s
Power Factor	0.85	Hmax	23.5 m

Firmware

Version	21
Variant	DOL12A Direct

Annotations:

- A red circle highlights the '400V 50Hz' value in the Volt field.
- A red circle highlights the '7.0 A' value in the Amp field.

Text Boxes:

- Left Box:** Name plate data shall be consistent to physical name plate on pump specially look on voltage, frequency and amperage.
- Right Box:** Version shows software version within pump. New firmware is available on server if you need update, procedure is located on page service.

At the bottom right, there are buttons for 'OK', 'Quit', 'Apply', and 'Help'.

AquaTronic display

Tab 1 - Language and unit settings

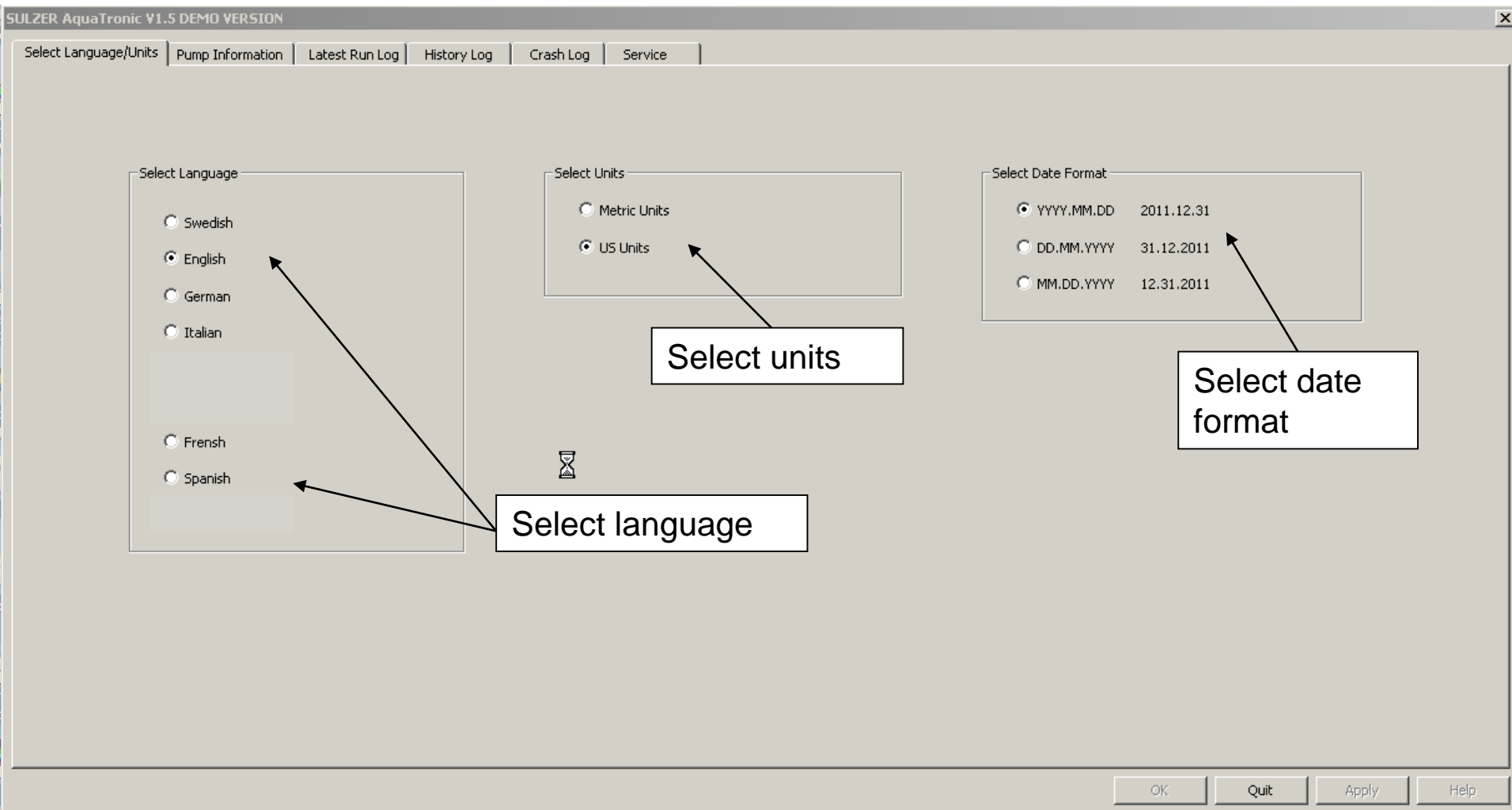

AquaTronic memory

- Processor in AquaTronic unit stores run data on an USB memory that you can reach when the pump is not energised.
- AquaTronic stores:
 - Last 20 hours running voltage (x3), amperage (x3), power factor, AquaTronic temperature (heat sink), motor temperature, ground fault current (or ground fault resistance on older versions), oil resistance (water in oil).
 - History log where data is summed up during pumps lifetime, same physical measures as above plus fault counters.
 - Crash log where 10 last minutes is stored before an alarm have been triggered, 16 crashes can be stored.
 - Service manual, spare part list and service log book.

General behaviour of XJ Service Data Kit

AquaTronic unit do not have internal clock and cannot measure when out of power.

This may cause the graphs to make a “jump”.

One way to observe this “non recording” time is to look at motor temperature. Motor temperature shall move slowly.

If motor temperature makes a jump you know that some time have elapsed.

AquaTronic display

Tab 3 - "Latest run log" (data from latest 1200 min)

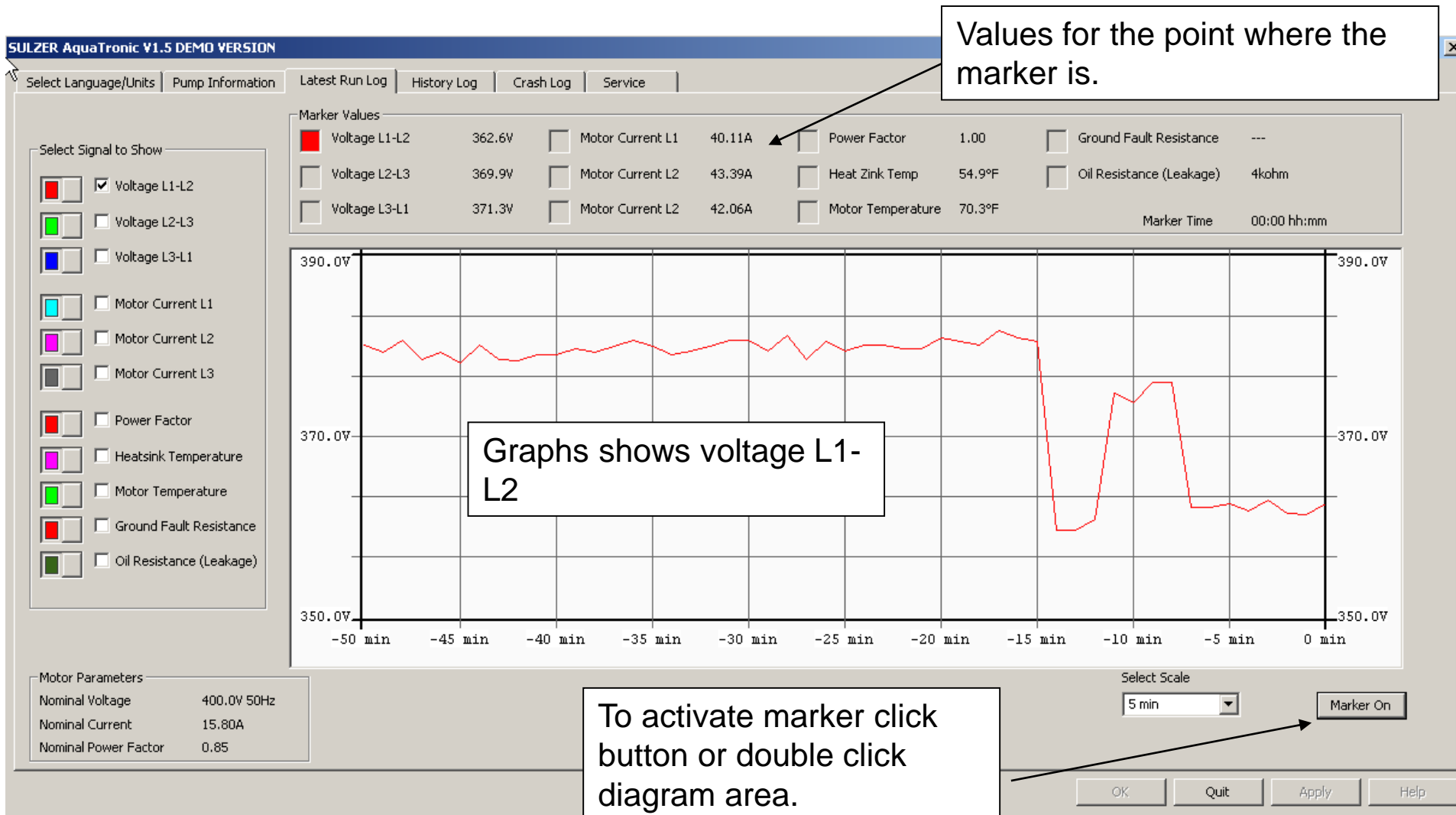

Comparison real time start/stop AquaTronic start/stop at external start/stop action

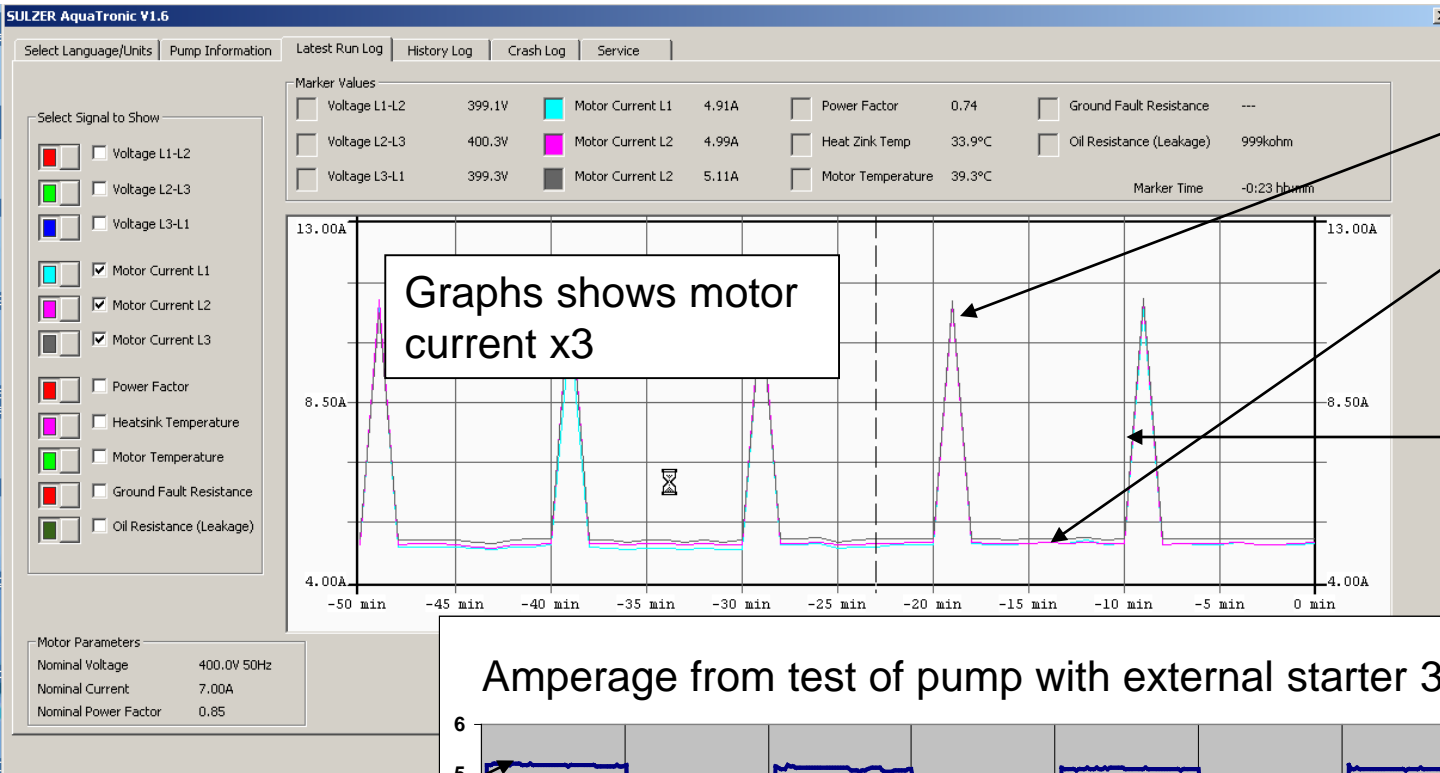

Start sequence

Run period normal power

Stop period is not showing as AquaTronic has no power.

Amperage from test of pump with external starter 3 starts / hour

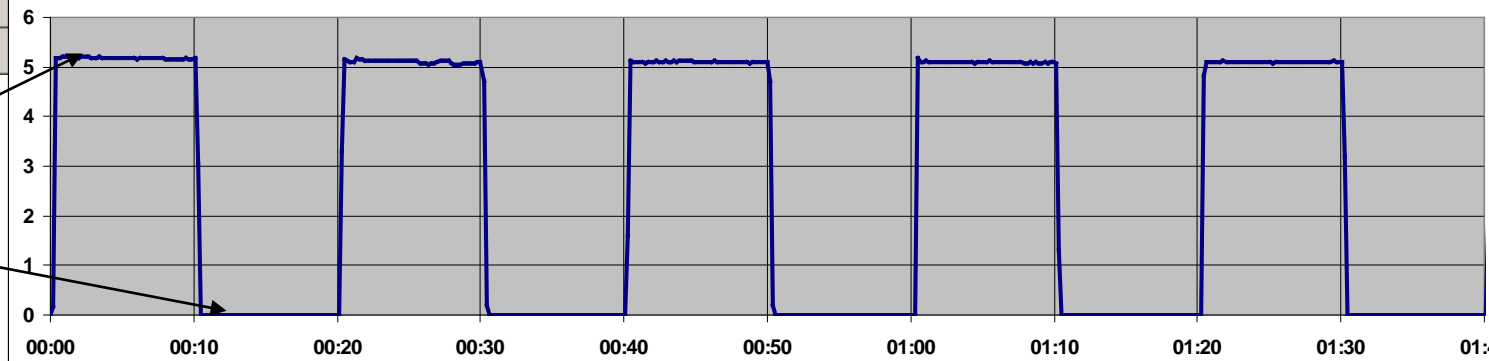

Run period

Stop period

Another way to see if the pump has been standing or running is often to select motor temperature. As you can see below, the motor is slowly warming up during run period and then the temperature suddenly drops down. This sudden drop is an indication of time passing without being measured (recorded).

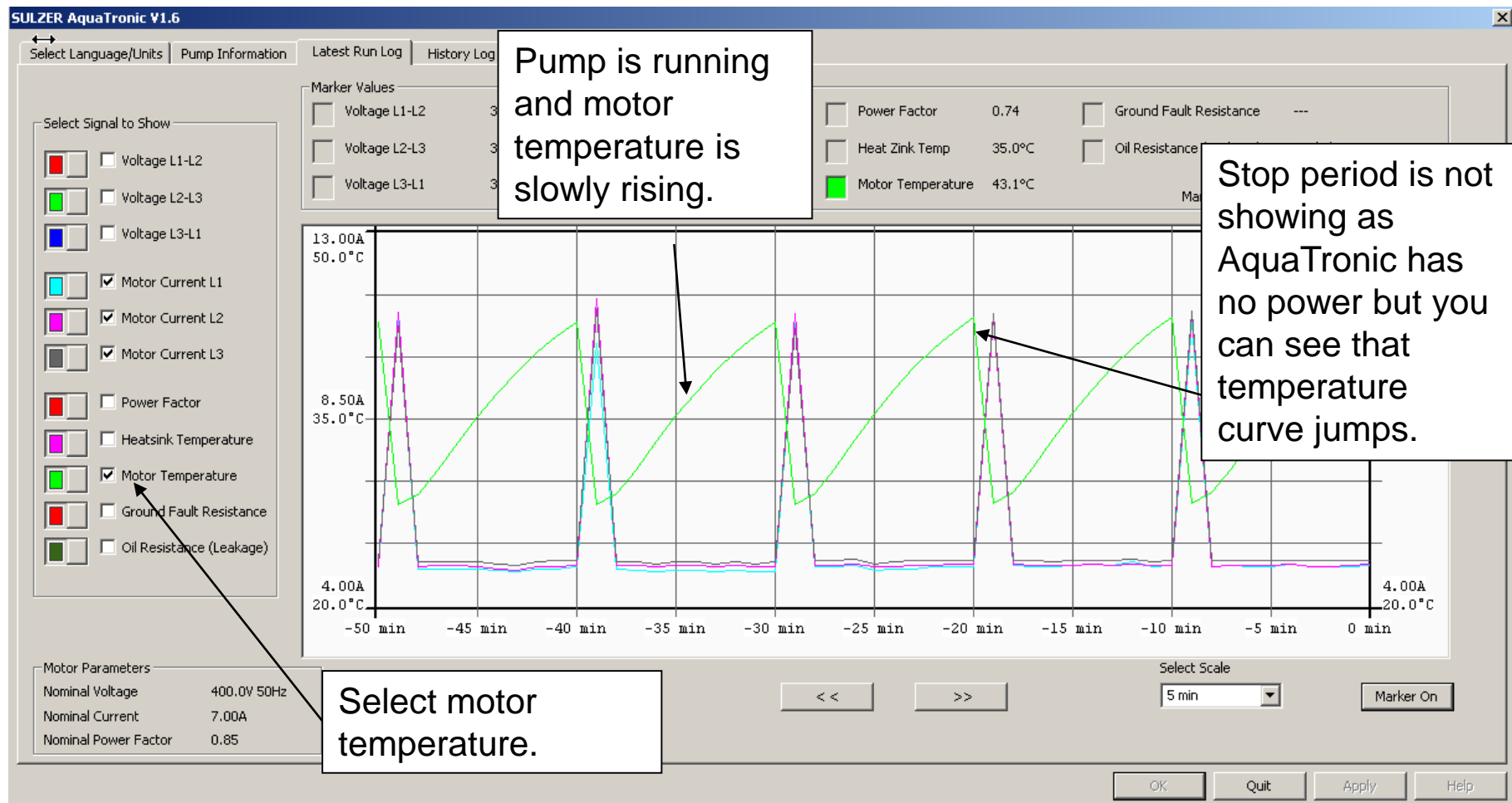

AquaTronic display Tab 4 - History log (pump full life)

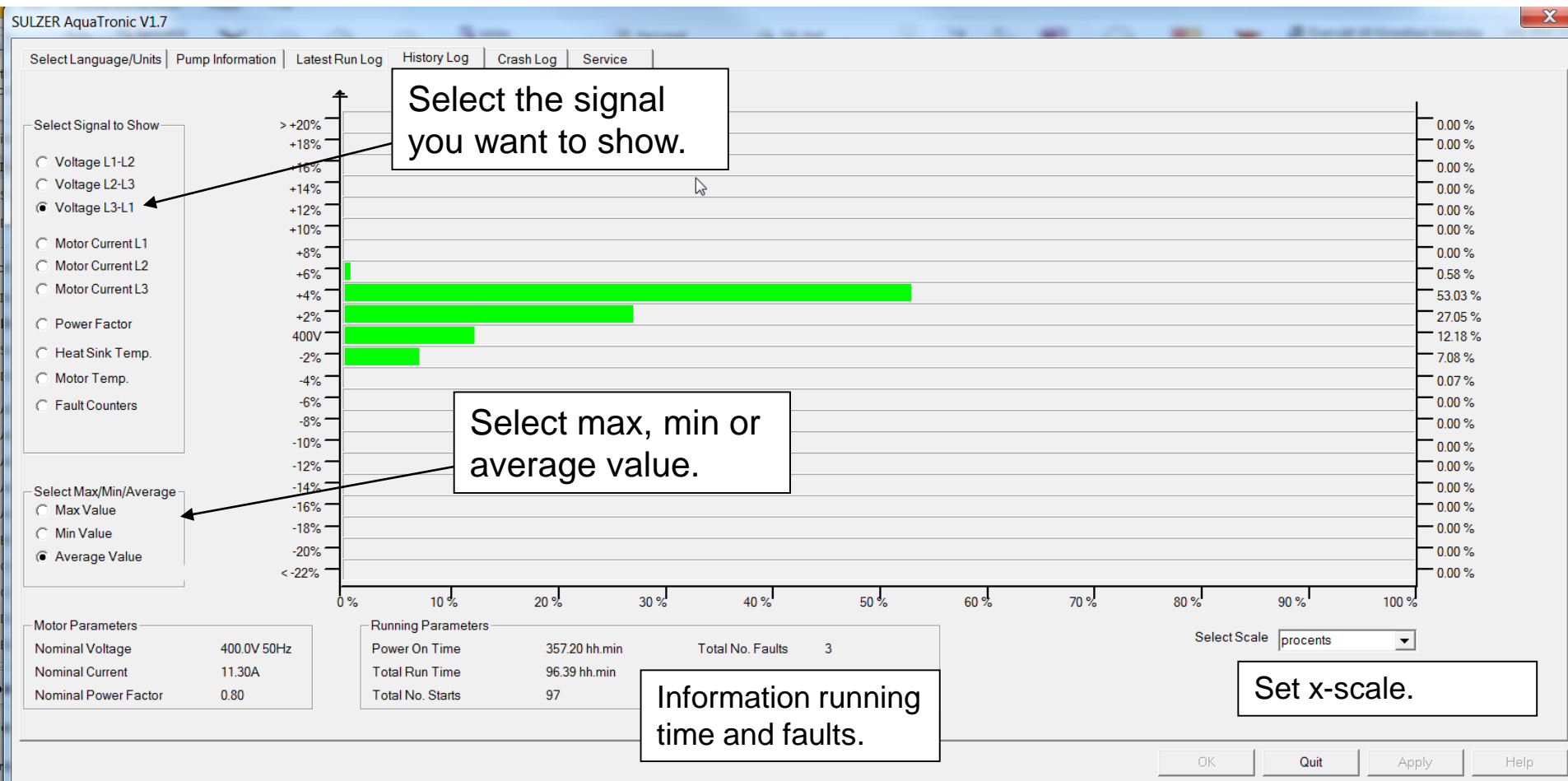

AquaTronic display Tab 4-1 - History log / fault counters

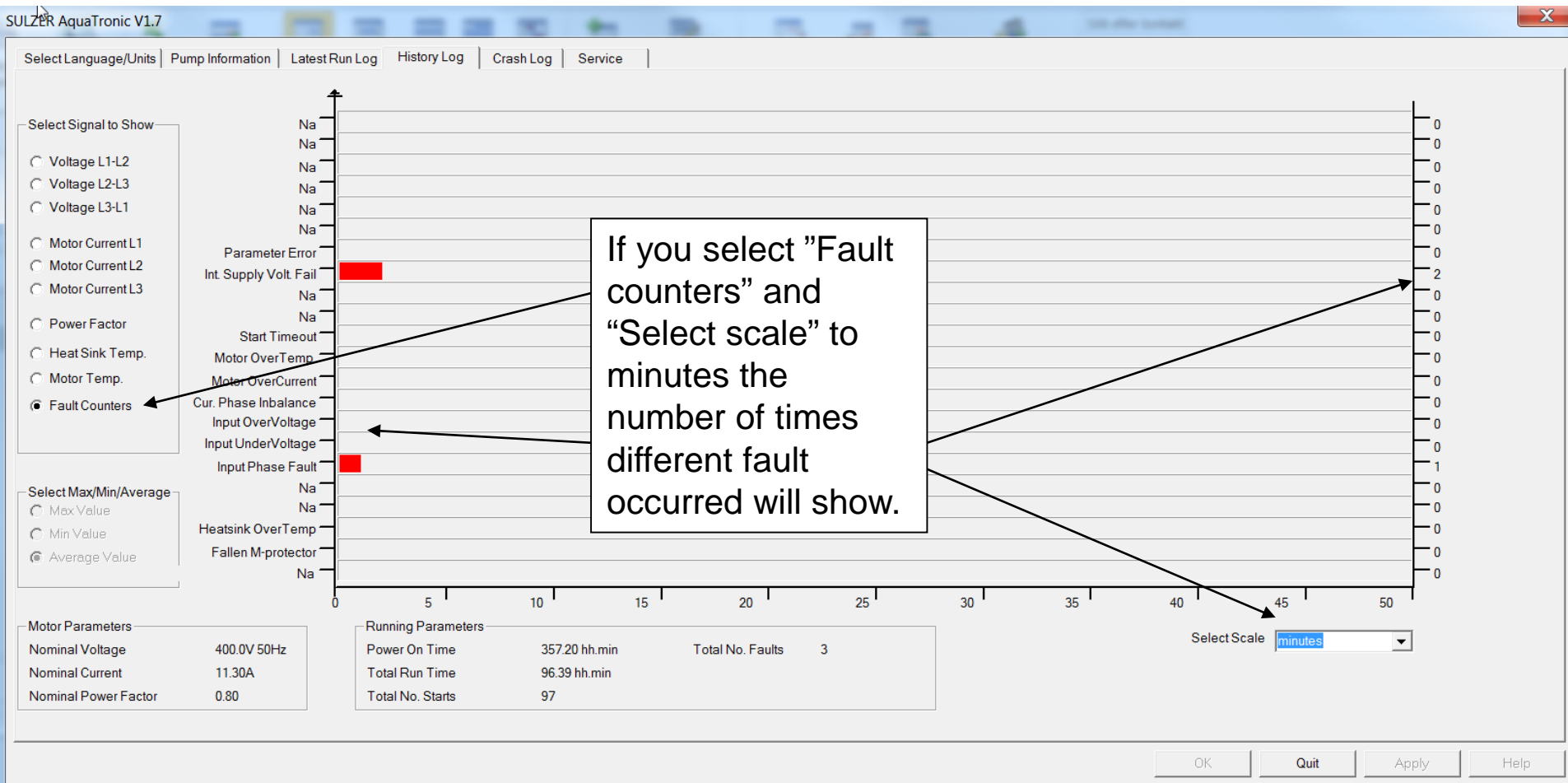

History log / fault counters understanding

- Parameter error = Software has dropped set parameters (very uncommon)
- Int. supply volt. fail = AquaTronic internal voltage has failed
- Start timeout = More than 4 seconds on start with soft start = Locked rotor
- Motor over temp. = Motor NTC giving indication of temperature beyond 140 °C
- Motor over current = Motor current more than 20 % over nominal amperage for more than 100 seconds
- Cur. phase unbalance = More than 20 % difference between phase amperage
- Input over voltage = Voltage more than 20 % above nominal
- Input under voltage = Voltage more than 20 % below nominal
- Input phase fault = One phase is missing
- Heat-sink over temperature = AquaTronic internal temperature above allowed. AquaTronic SS 60 °C, AquaTronic DS 80 °C
- Fallen M-protector = Short time current overload, AquaTronic SS this is 3.5 times nominal (start current is 3x nominal) on AquaTronic DS this is set to 11x nominal (start current is 7-9 x nominal)

AquaTronic display

Tab 5 - Crash log (data from 10 last alarms)

SULZER AquaTronic V1.5 DEMO VERSION

Select Language/Units | Pump Information | Latest Run Log | History Log | **Crash Log** | Service

Voltage L1-L2 --- Current L1 --- Power Factor --- Ground Fault Res. ---
 Voltage L2-L3 --- Current L2 --- Heat Sink Temp. ---
 Voltage L3-L1 --- Current L3 --- Motor Temp. ---

Select Signal to Show

Voltage L1-L2 Max Value
 Voltage L2-L3
 Voltage L3-L1
 Current L1 Max Value
 Current L2
 Current L3
 Power Factor Max Value
 Heat Sink Temp. Max Value
 Motor Temp. Max Value
 Ground Fault Res. Max Value

110kohm
55kohm
0kohm

-9 min -8 min -7 min -6 min -5 min -4 min -3 min -2 min -1 min 0 min

50.0V
2.00A
PF 1.00

25.0V
1.00A
PF 0.50

0.0V
0.00A
PF 0.00

Show Crash Log

<< Crash Log 1 (Latest) >>

PUMP SETTINGS NO DATA
FAULT REASON NO DATA

Motor Parameters
Nominal Voltage 400.0V 50Hz
Nominal Current 15.80A
Nominal Power Factor 0.85

Show Table < Marker >

Click button "Show table" and change to next slide.

To activate marker click button or double click diagram area.

OK Quit Apply Help

AquaTronic display

Tab 5-1 - Crash log (data from 10 last alarms)

SULZER AquaTronic V1.6

Select Language/Units | Pump Information | Latest Run Log | History Log | **Crash Log** | Service

■ Voltage L1-L2 406.0 V ■ Current L1 9.14 A ■ Power Factor 0.91 ■ Ground Fault Res. 551 kohm
■ Voltage L2-L3 405.0 V ■ Current L2 9.22 A ■ Heat Sink Temp. 109.9 °C
■ Voltage L3-L1 406.9 V ■ Current L3 9.02 A ■ Motor Temp. 113.5 °C

Select Signal to Show

560kohm

410.0V
10.00A
0°C

AquaTronic : Show CrashLog 12

Time	Voltage L1-L2 V	Voltage L2-L3 V	Voltage L3-L1 V	Motor Current L3 A	Motor Current L3 A	Motor Current L3 A	Hest Sink Temperature °C	Motor Temperature °C	Ground Fault Resistance kohm
0min	405.5	404.6	406.5	9.06	9.18	8.98	110.0	113.5	544
-1min	405.7	404.8	406.7	9.10	9.18	9.02	110.0	113.5	542
-2min	406.0	405.0	406.9	9.14	9.22	9.02	109.9	113.5	551
-3min	406.2	405.3	406.9	9.18	9.30	9.06	109.9	113.5	550
-4min	406.0	405.0	406.7	9.14	9.22	9.02	109.9	113.5	538
-5min	406.7	405.5	407.6	9.22	9.34	9.14	109.8	113.5	534
-6min	406.9	406.0	407.6	9.26	9.30	9.14	109.8	113.4	538
-7min	406.7	405.7	407.6	9.18	9.22	9.02	109.7	113.4	535
-8min	407.2	406.0	407.9	9.22	9.30	9.10	109.7	113.4	531
-9min	406.2	405.3	406.9	9.18	9.30	9.06	109.9	113.5	550
	Max Value	Max Value	Max Value	Max Value	Max Value	Max Value	Max Value	Max Value	Max Value

OK Cancel

Show Crash L

<< Crash Log 12 >> FAULT REASON Hea

Nominal Power Factor 0.85

0V
A
0°C

0V
A
0°C

OK Quit Apply Help

The data for the signal you have chosen is shown.

AquaTronic display Tab 6 - Service and data upgrade

SULZER AquaTronic V1.5 DEMO VERSION

Select Language/Units | Pump Information | Latest Run Log | History Log | Crash Log | Service

UPGRADE FIRMWARE DRAIN PUMP

Service Log

“Spare part list” or “Workshop manual” for pump in pdf format.

Open Spare Part List

Open Workshop Manual

Open Service Log

Open “Service log” and change to next slide.

Current Firmware Version

Version	21
Type/Option	SS16A Soft Start

New Firmware Version (loaded from file)

Version	---
Type/Option	---

Open Firmware File (.smf) for Upgrade

Download Firmware to Drain Pump

Cancel Operation

OK Quit Apply Help

AquaTronic display

Tab 6-2 Service and data upgrade

The screenshot shows the AquaTronic V1.5 DEMO VERSION software interface. The main window has a 'Service' tab selected. A callout box states: "This is how the service log looks and it can be used for service notes." The interface includes a 'Service Log' section with a pencil icon and a 'UPGRADE FIRMWARE DRAIN PUMP' section with a pump diagram. A Notepad window titled '38.LOG - Notepad' is open in the foreground, displaying the following log data:

```

2012.06.26 11:01:55      Log File Created
Service Log Drain Pump XJS25D 38

2012.06.26 11:01:55      open Service Log
Total Number of Starts : 24      Total Run Time : 1322:29 hh:mm      Total Power On Time : 1322:38 hh:mm      Total No Faults : 5

In service log you can wright down anny information you want.
Every time service log have been opened it creates a login of starts and run time
    
```

At the bottom of the interface, there are several buttons: 'Open Spare Part List', 'Open Workshop Manual', 'Open Service Log', 'Open Firmware File (.smf) for Upgrade', 'Download Firmware to Drain Pump', 'Cancel Operation', 'OK', 'Quit', 'Apply', and 'Help'.

Faults that can occur in XJ submersible dewatering pumps.

Fault could be divided into two groups:

1. Faults caused by outer conditions:
 1. High load
 2. Voltage unbalance / phase failure
 3. Low or high voltage
 4. Pumps are not pumping

2. Faults caused by malfunction in pump or caused by outer conditions showing like faults in pump:
 1. Water in oil
Water / oil mixture in motor housing
Water in motor housing
 2. Bad insulation in windings / shortage to earth
 3. Shortage between phases in winding
 4. High temperature in winding
 5. High temperature in electronics
 6. Locked rotor
 7. Worn hydraulics

1.1 High load

- High load 20 % above nominal
- High load can be a result of many different things:
 - Too much material in pumped media. Power is direct proportionally to the weight of pump media (SG 1.2 or more). It will cause motor to draw too much current.
 - Stuck material between impeller and upper diffuser, lower diffuser or wear ring will make motor to run heavy and will also result in high current reading.
 - Oil that has penetrated into stator windings can also cause high current readings.
 - High voltage can also give high amperage causing trip out.
- Next page shows motor protection trip curve.

Motor current protection cut out curves

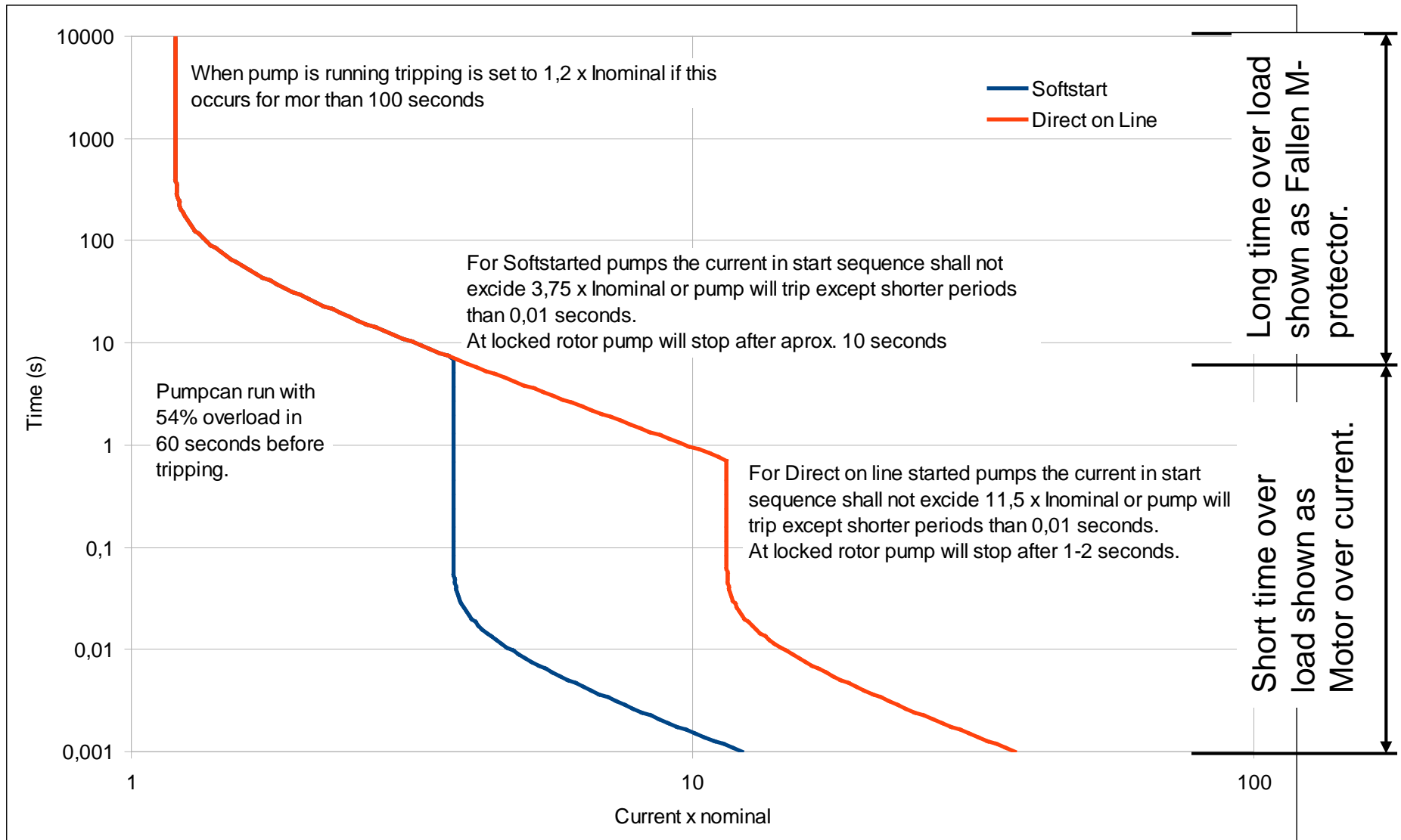

1.2 Voltage unbalance / phase failure

- Voltage unbalance is a fault caused by incoming power. An unbalanced voltage will give a result in unbalance in amperage. AquaTronic will cut out for an amperage unbalance that exceed 20 %.
- At phase failure AquaTronic cuts out immediately without delay

1.3 Low or high voltage

- ± 5 % is normal voltage. Pump shall perform as normal. No high amperage or temperature problems, Q-H-P as nominal.
- ± 10 % is possible without malfunction. No temperature problems, Q-H-P can go outside tolerance.
- ± 20 % pump will run without cut out. May cause temperature stop of pump, Q-H-P curves outside tolerance. Low voltage lower Q-H. High voltage high power.
- More than ± 20 % AquaTronic will cut out

1.4 Pumps are not pumping

- On XJS pumps volute can be full of air which causes the impeller to spin without gripping water enough to create pressure to start pumping. This can be solved by tilting pump body and release air pocket.
- Pumps can also be worn so no water discharge is possible.

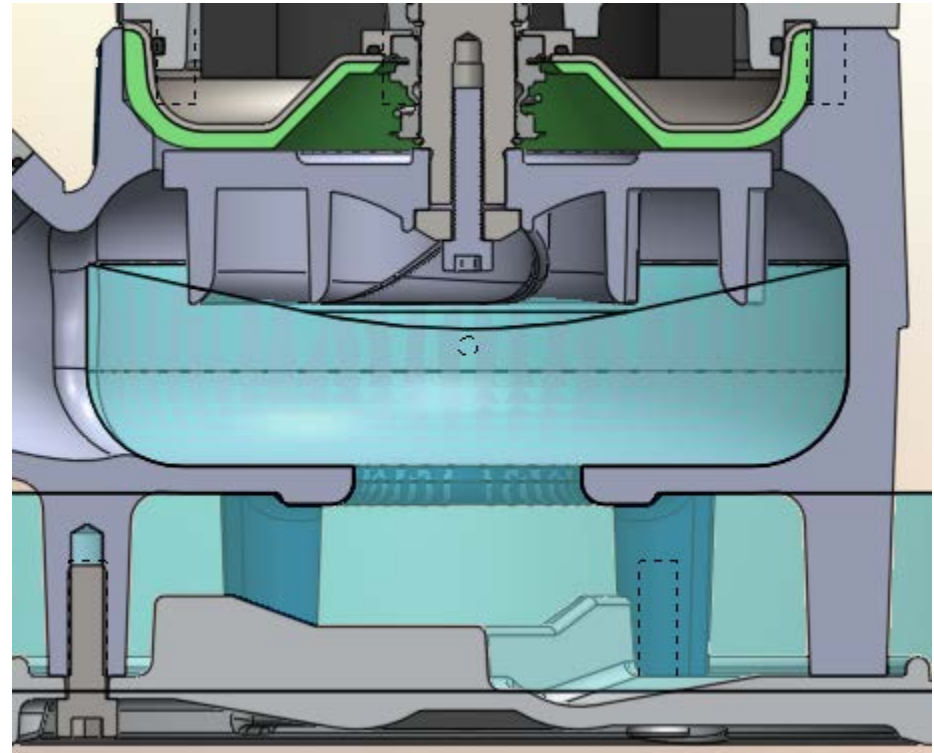

2.1 Water in oil

How to understand ground fault current (or ground fault resistance) and oil resistance.

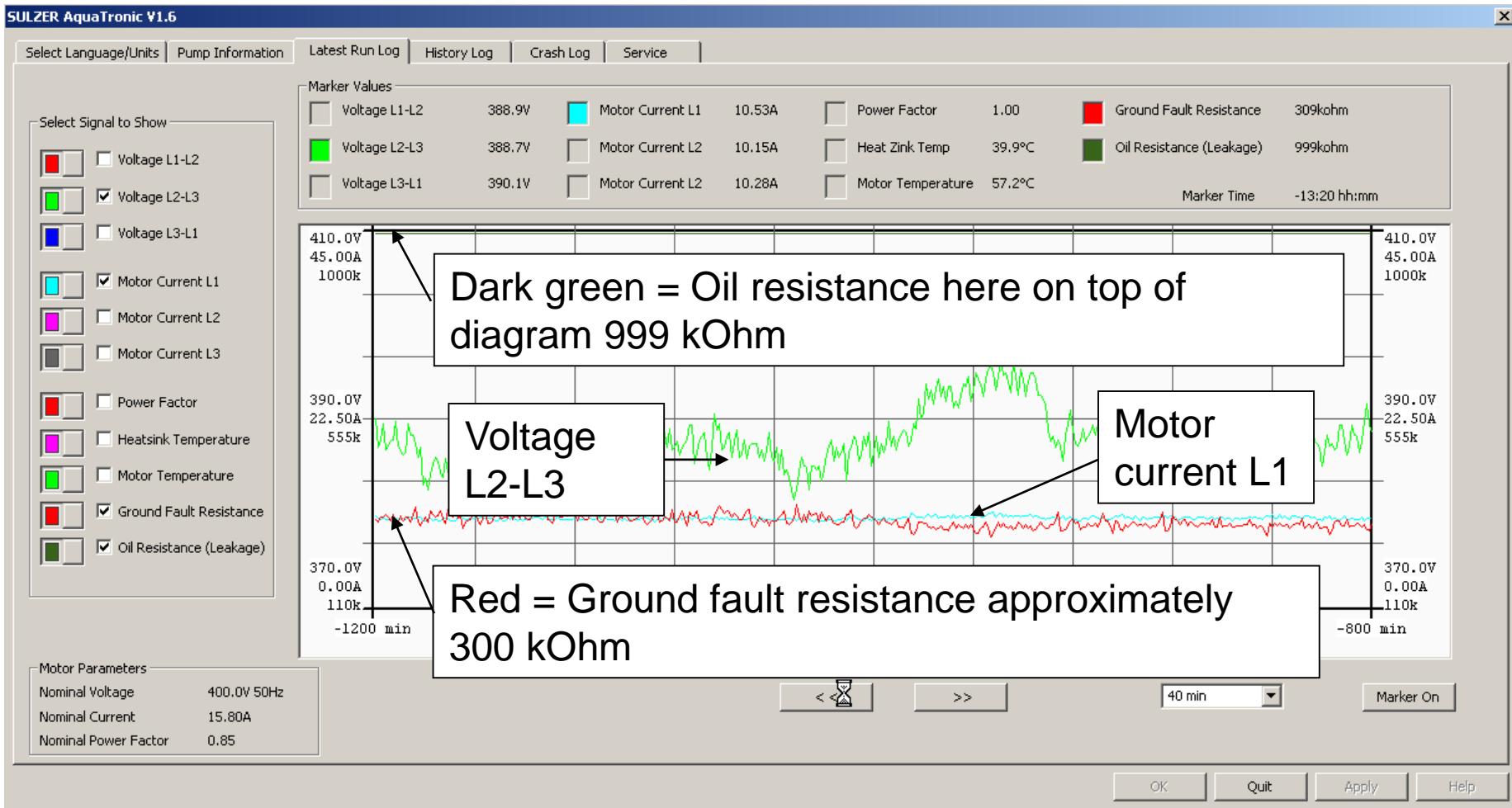

2.1 Water in oil

Oil resistance or water in motor housing

- Oil resistance is mostly a high value (800-999 kOhm), where 999 kOhm is the maximum measurement shown in these diagrams.
- Oil resistance values below 10 kOhm is too low and seals and oil have to be changed, do also check winding status.

2.1 Water in oil

Moisture sensor location in XJ pumps

- If water entered at top of sensor in motor house resistance will drop quick.
- If water enter through primary seal it will mix with oil and the resistance can drop less distinct (value can jump up and down for a while).

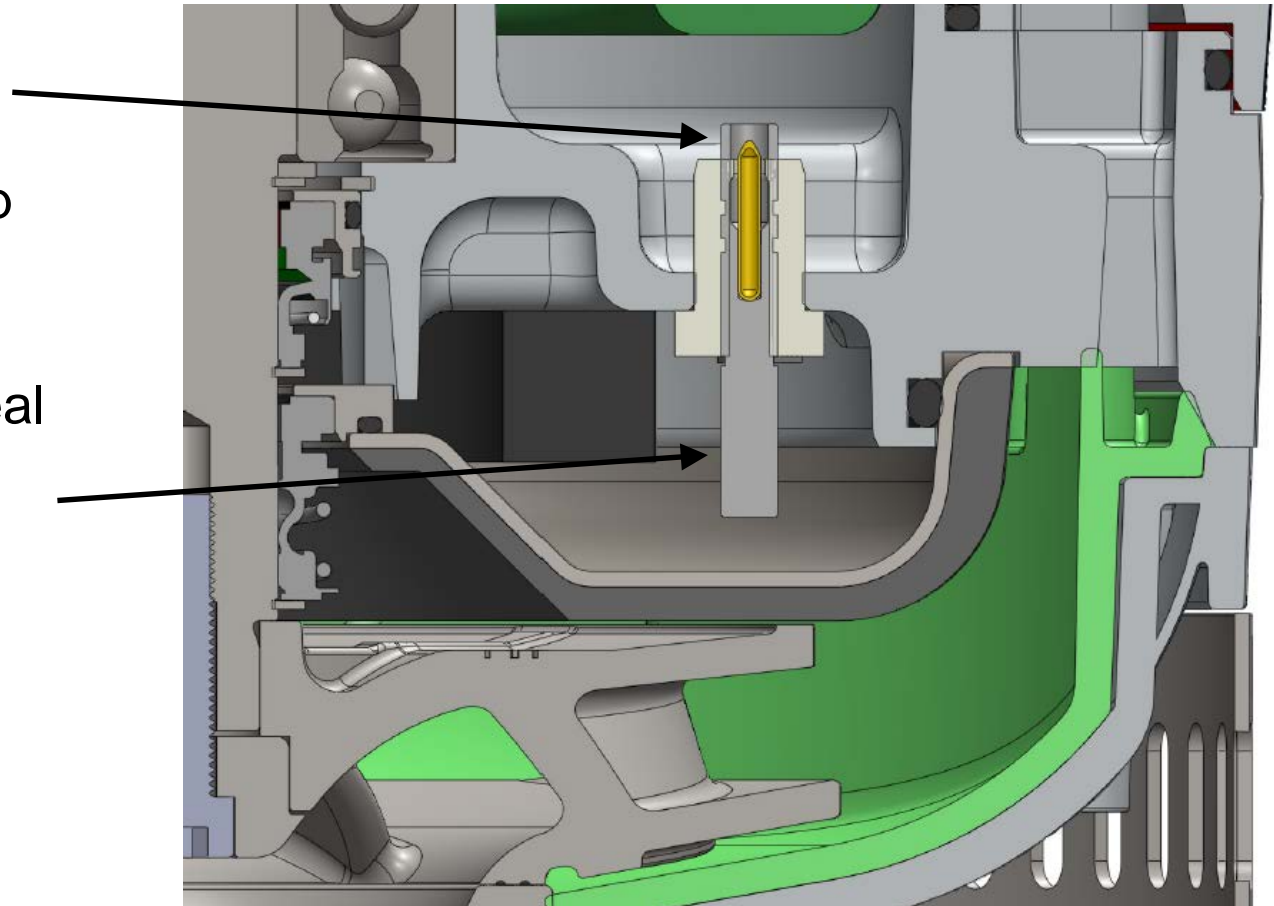

2.1 Water in oil

Example of oil resistance that drops quickly showing water in motor housing.

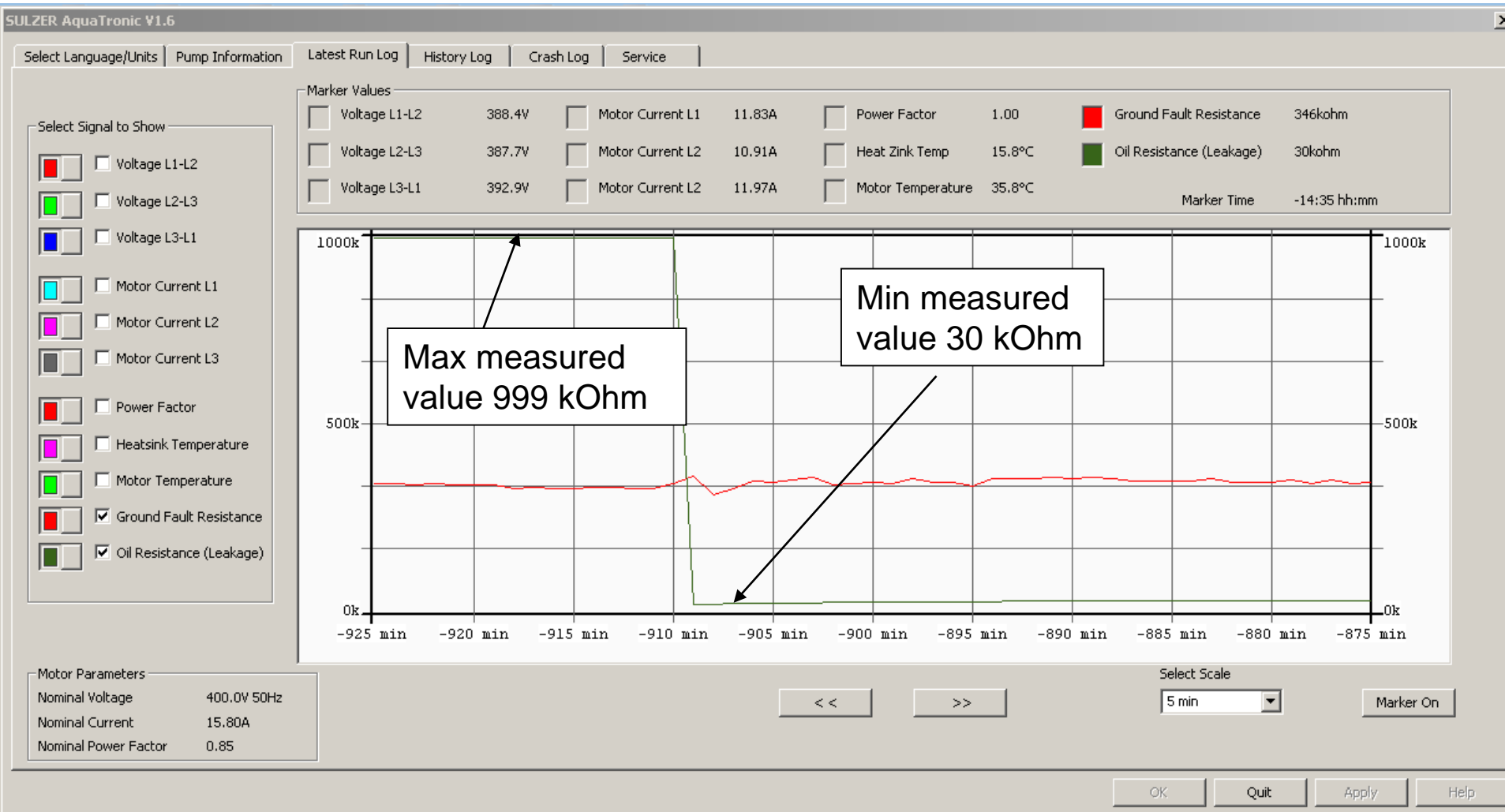

2.1 Water in oil

Example on oil resistance that drops showing water in oil. Water in oil measurement can drop quickly or jump up and down for a time before getting a low figure.

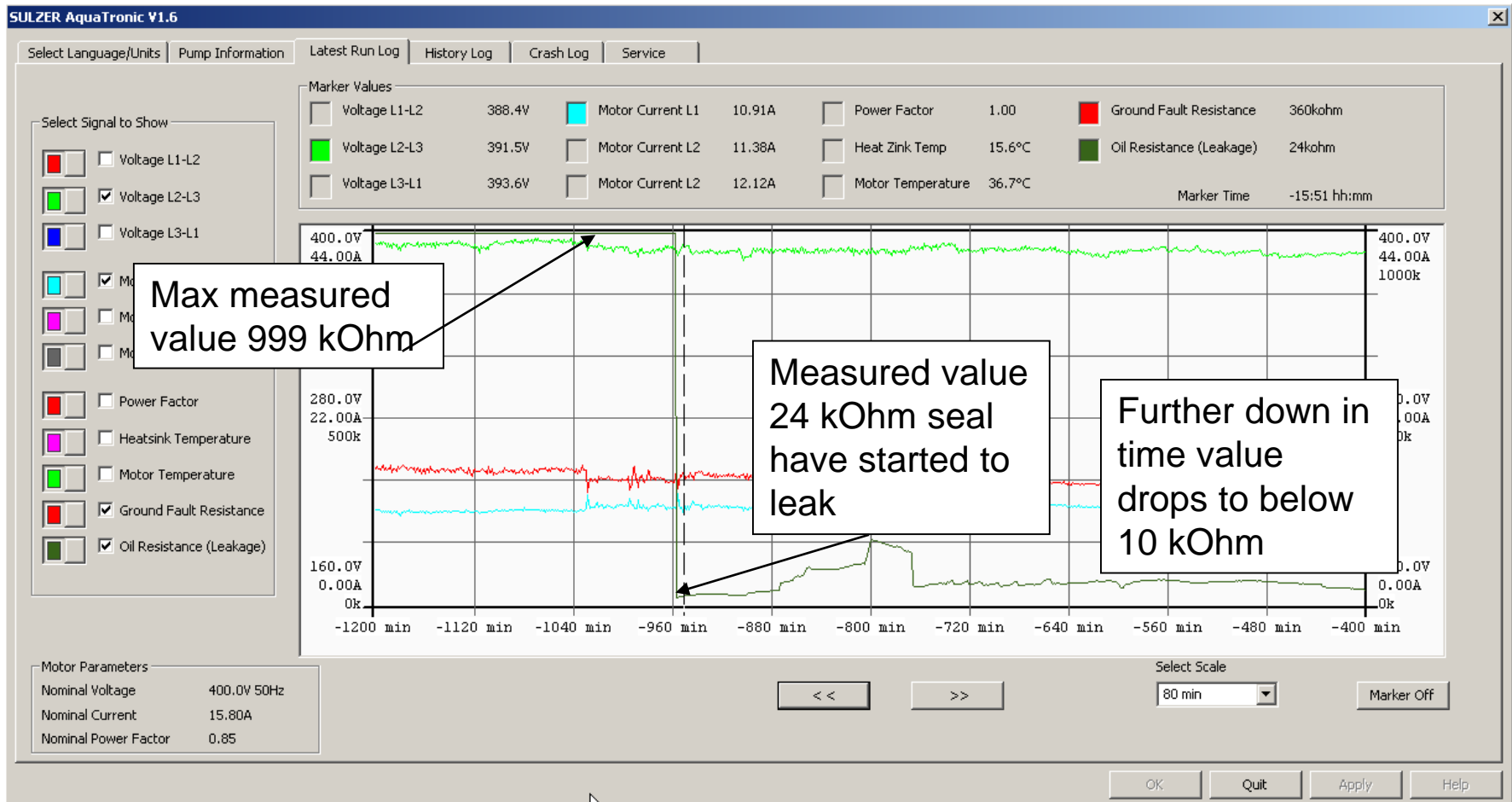

2.1 Water in oil

Continues from earlier graph down to 0 min showing oil resistance that dropping down below 10 kOhm, showing water in oil. Water in oil measurement can drop quickly or jump up and down for a time before getting a low figure.

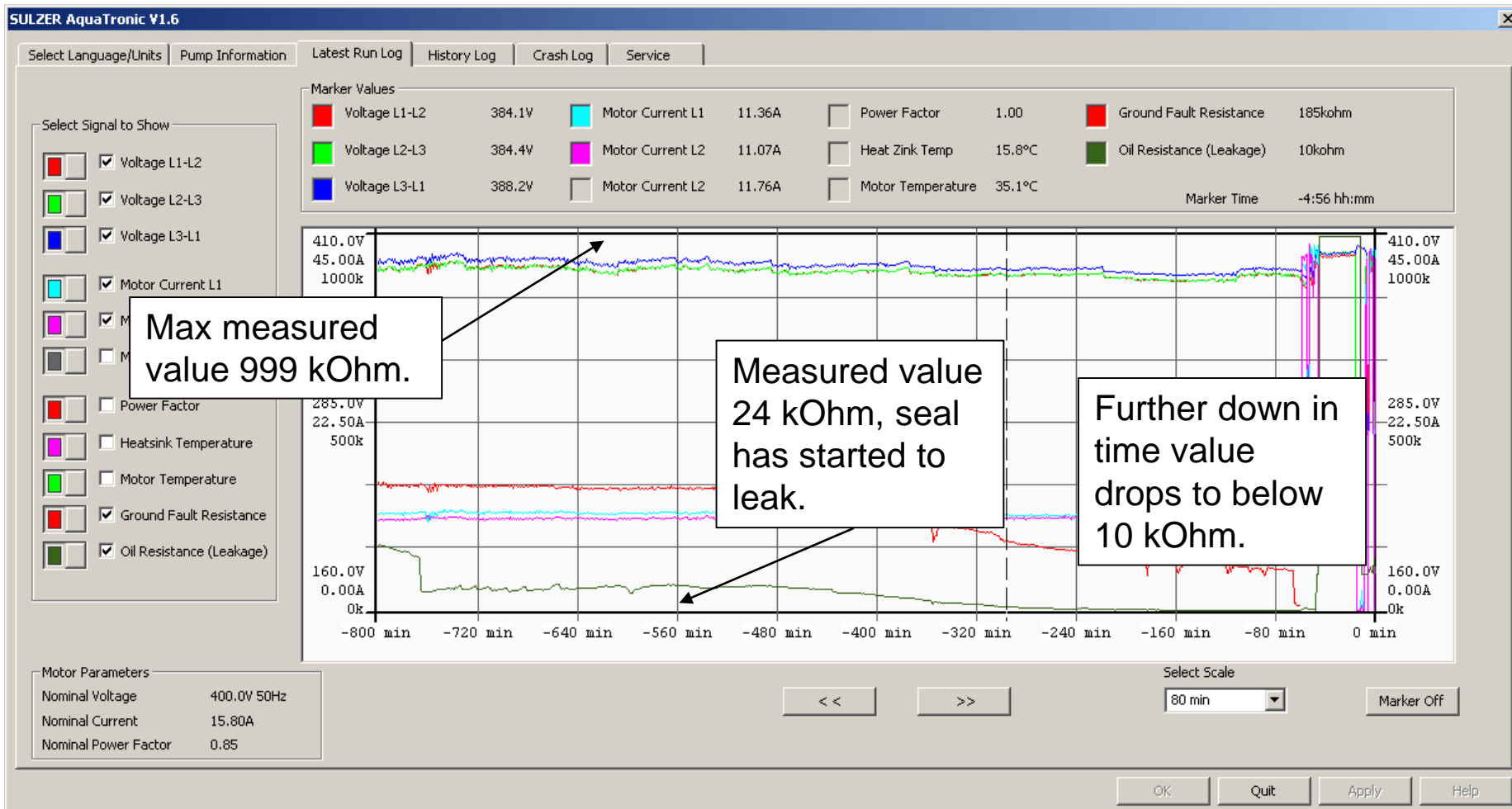

2.1 Water in oil

Example on oil resistance showing drops in measurement that are not for real, it is just a function of start current (no fault).

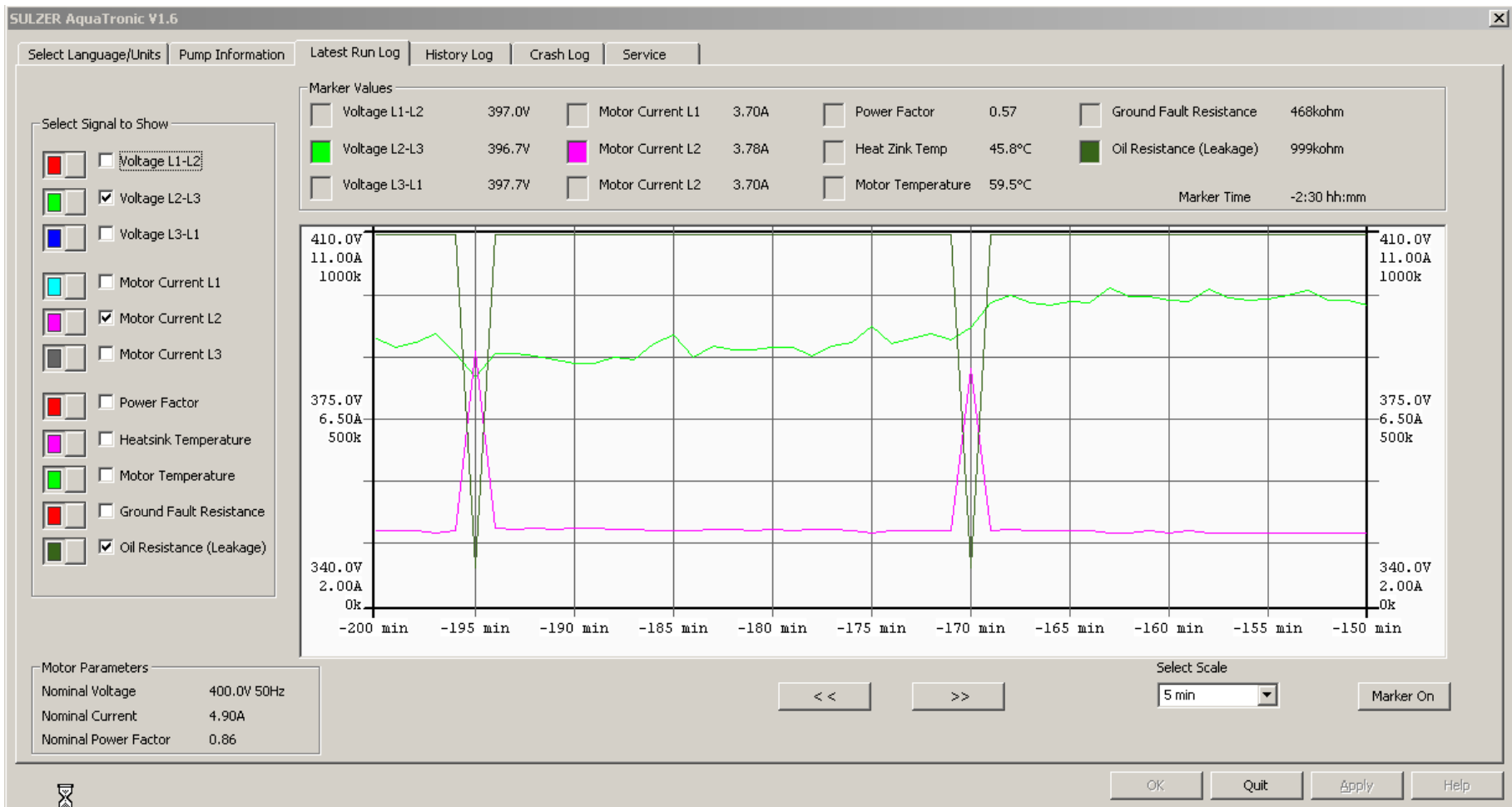

2.2 Ground fault current or ground fault resistance

- Ground fault current measurement (can also be measured ground fault resistance) shall be stable if measurement is rising moisture is entering in winding and motor needs dry out and if that do not help winding needs to be changed.
- Ground fault current measurement above 30 mA is too much (or ground fault resistance below 100 kOhm).

2.2 Ground fault current or ground fault resistance

Ground fault resistance is OK even if it jumps up and down as below. Be aware of scale! This sample max value is 551 kOhm and minimum is 531 kOhm. It is normal that resistance change with heat in winding.

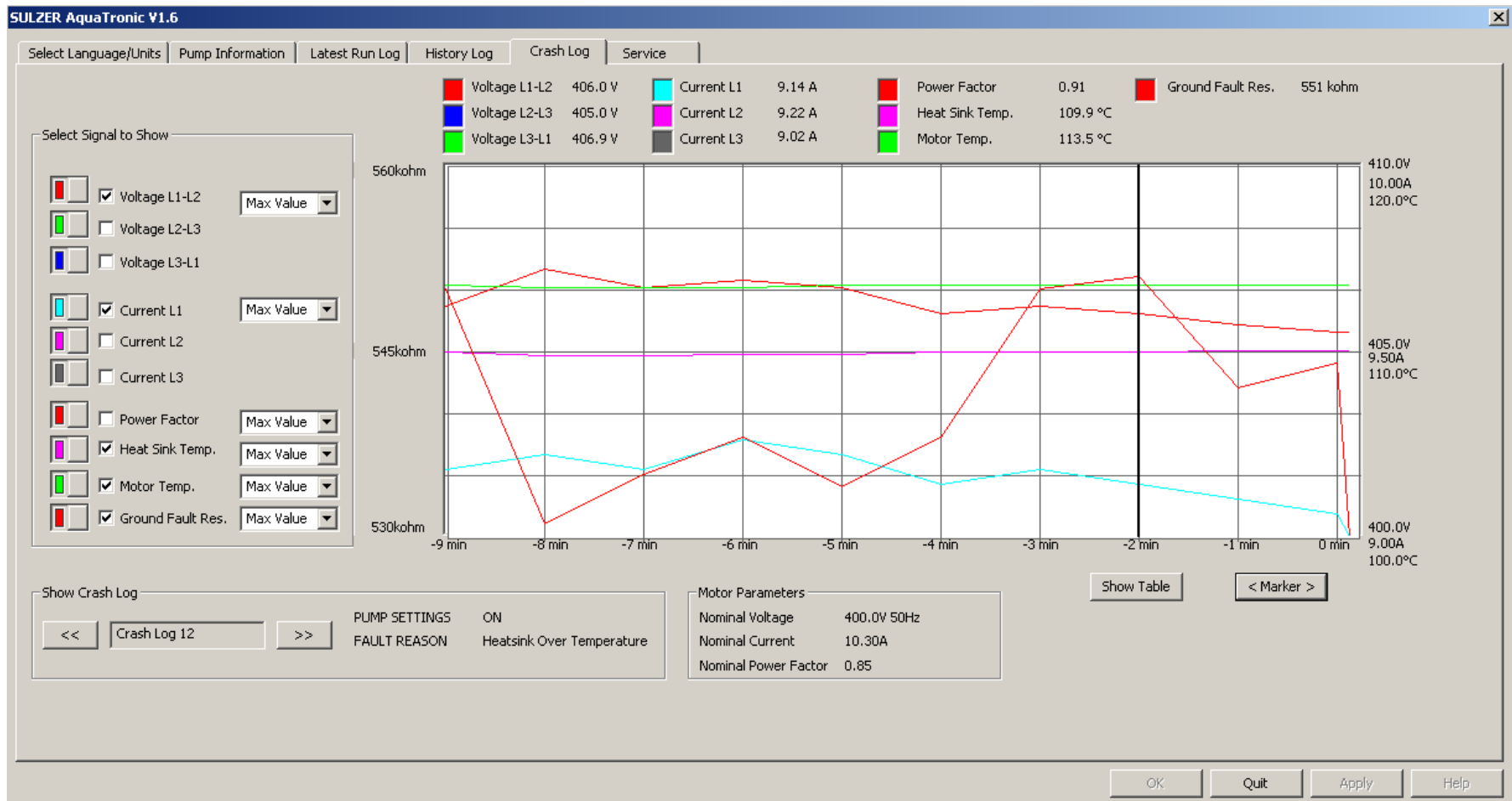

2.2 Ground fault current or ground fault resistance

Example on ground fault resistance that drops showing moisture in winding.

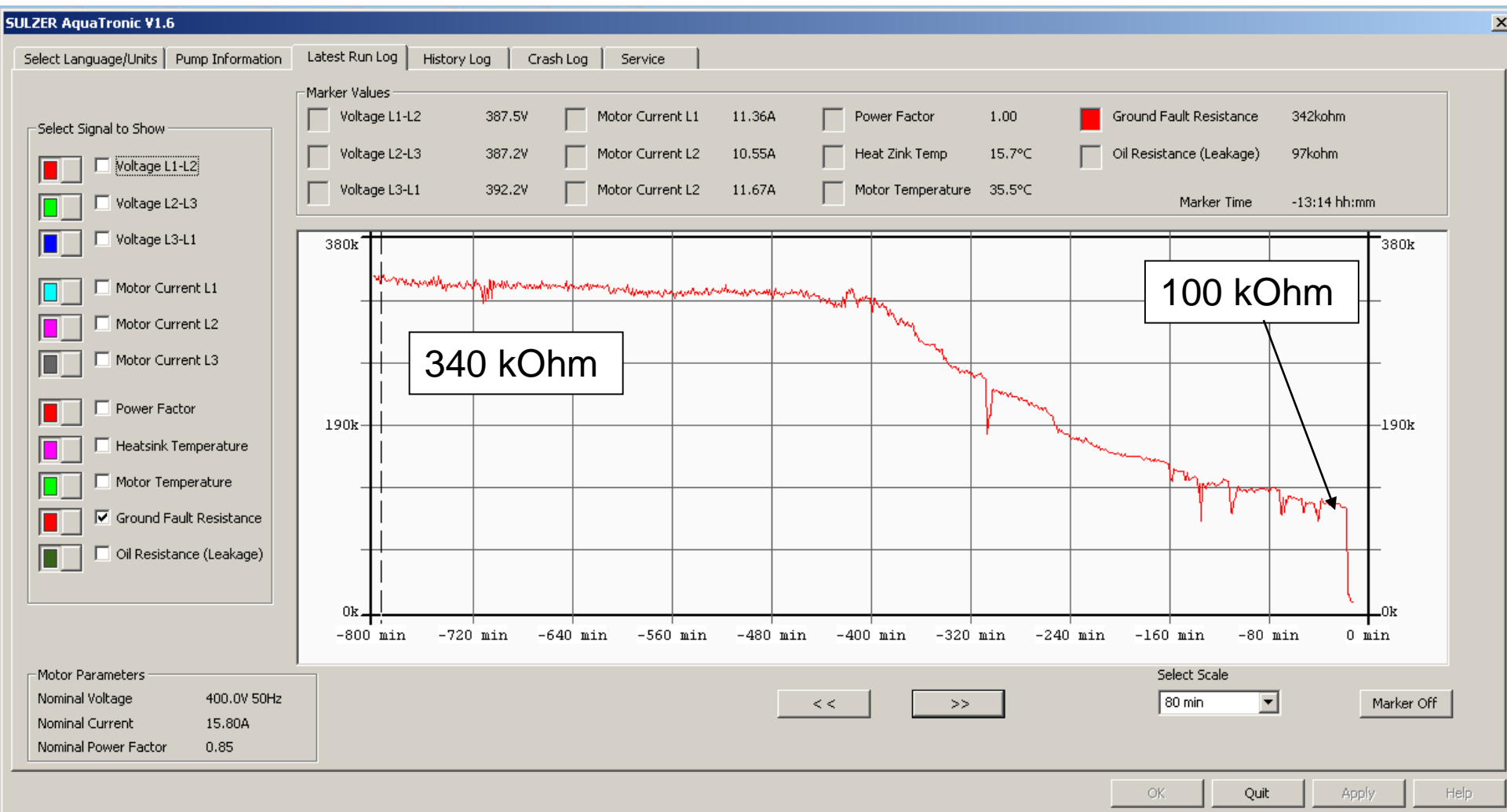

2.3 Shortage between phases in winding

- This will show as phase unbalance and/or motor overload.
- Shortage between phases is normally caused by voltage surges or spikes that come from power supply. It can also appear due to bad insulation of winding or wear of parts in winding.

2.4 High temperature in winding

AquaTronic will cut out at temperatures exceeding 140°C.

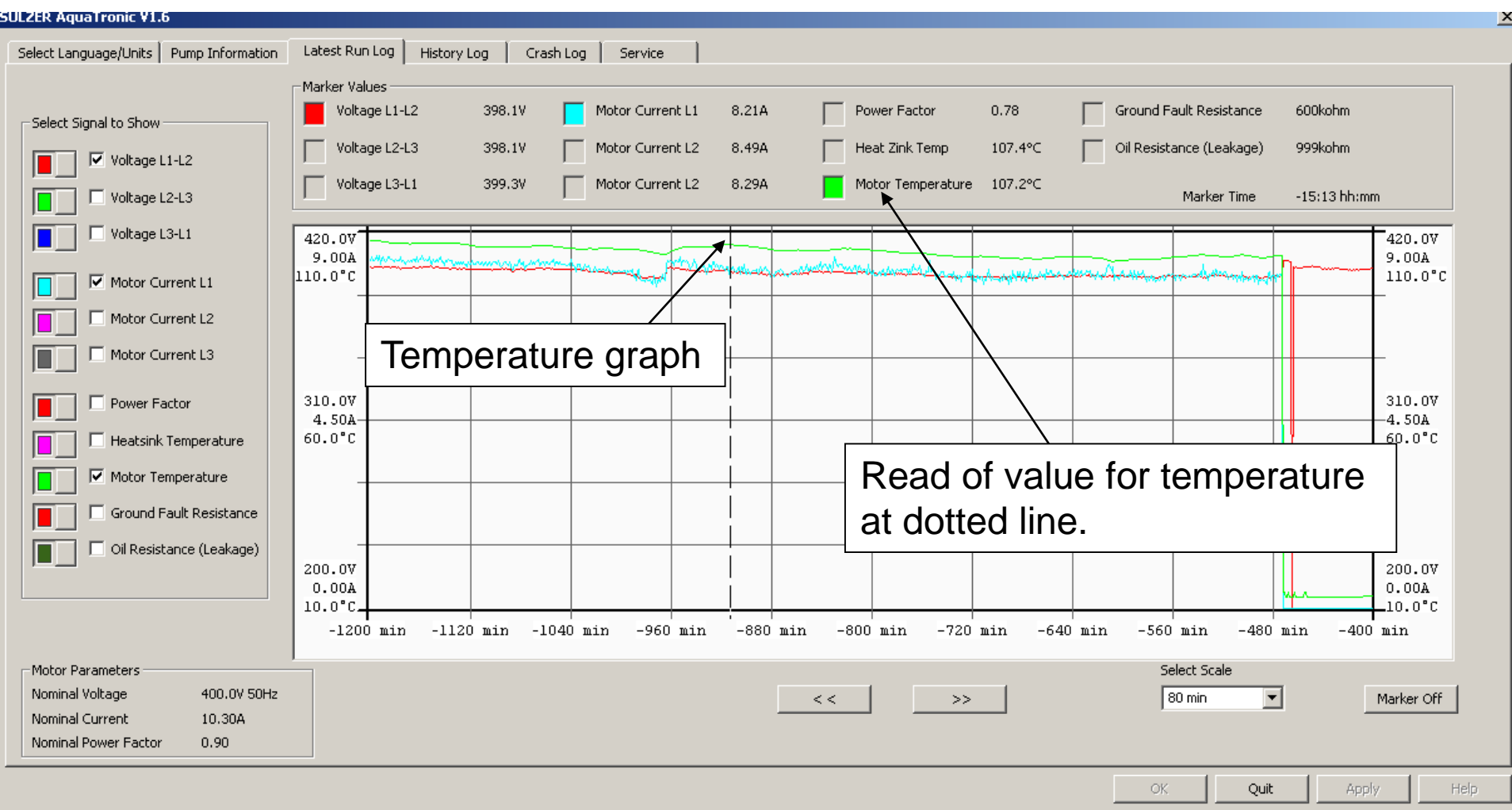

2.4 High temperature in winding Can also be read from history log

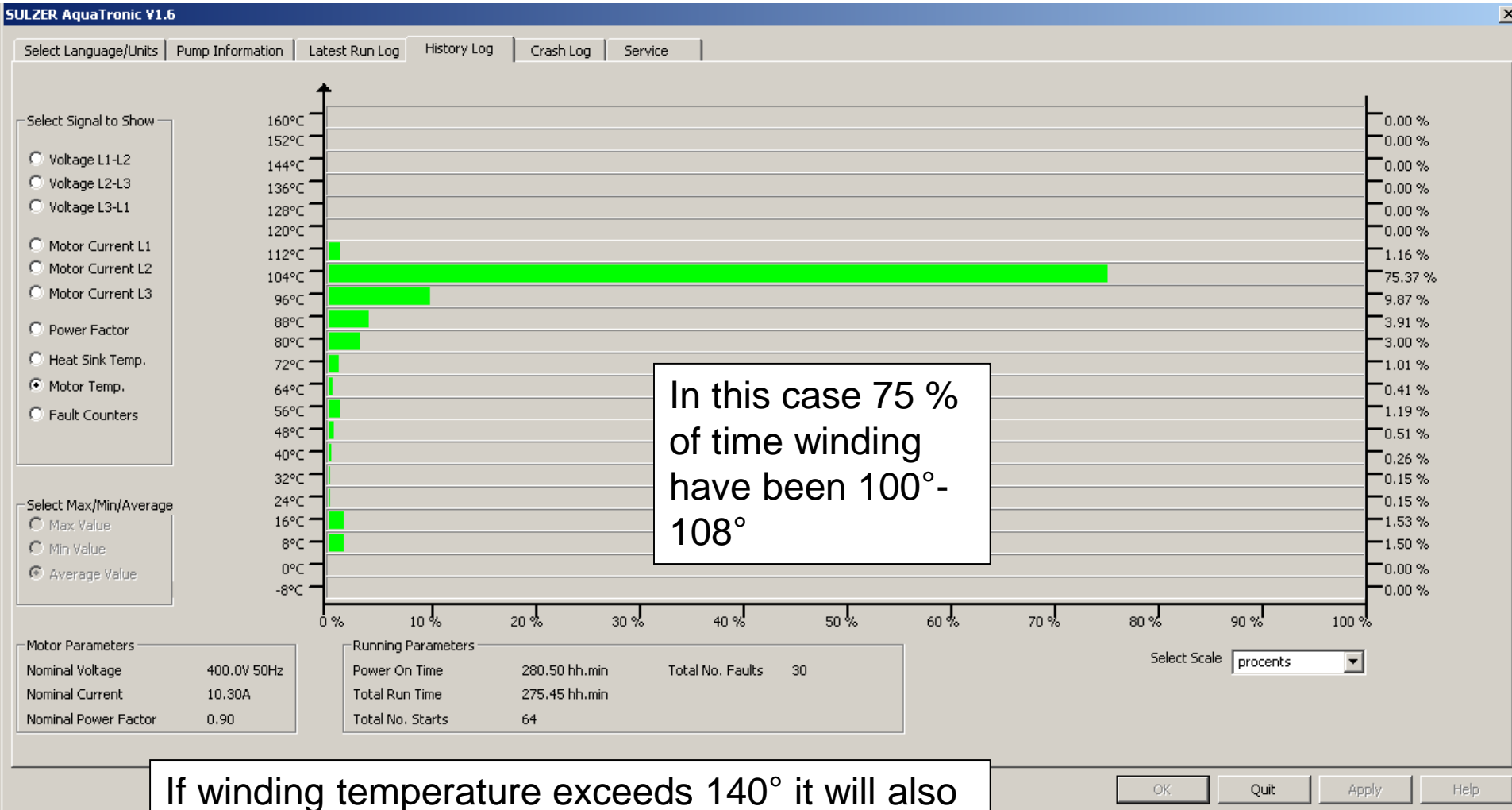

2.5 High temperature in electronics

Direct started AquaTronic will cut out at temperatures exceeding 110°C

Soft start AquaTronic will cut out at temperatures exceeding 80°C

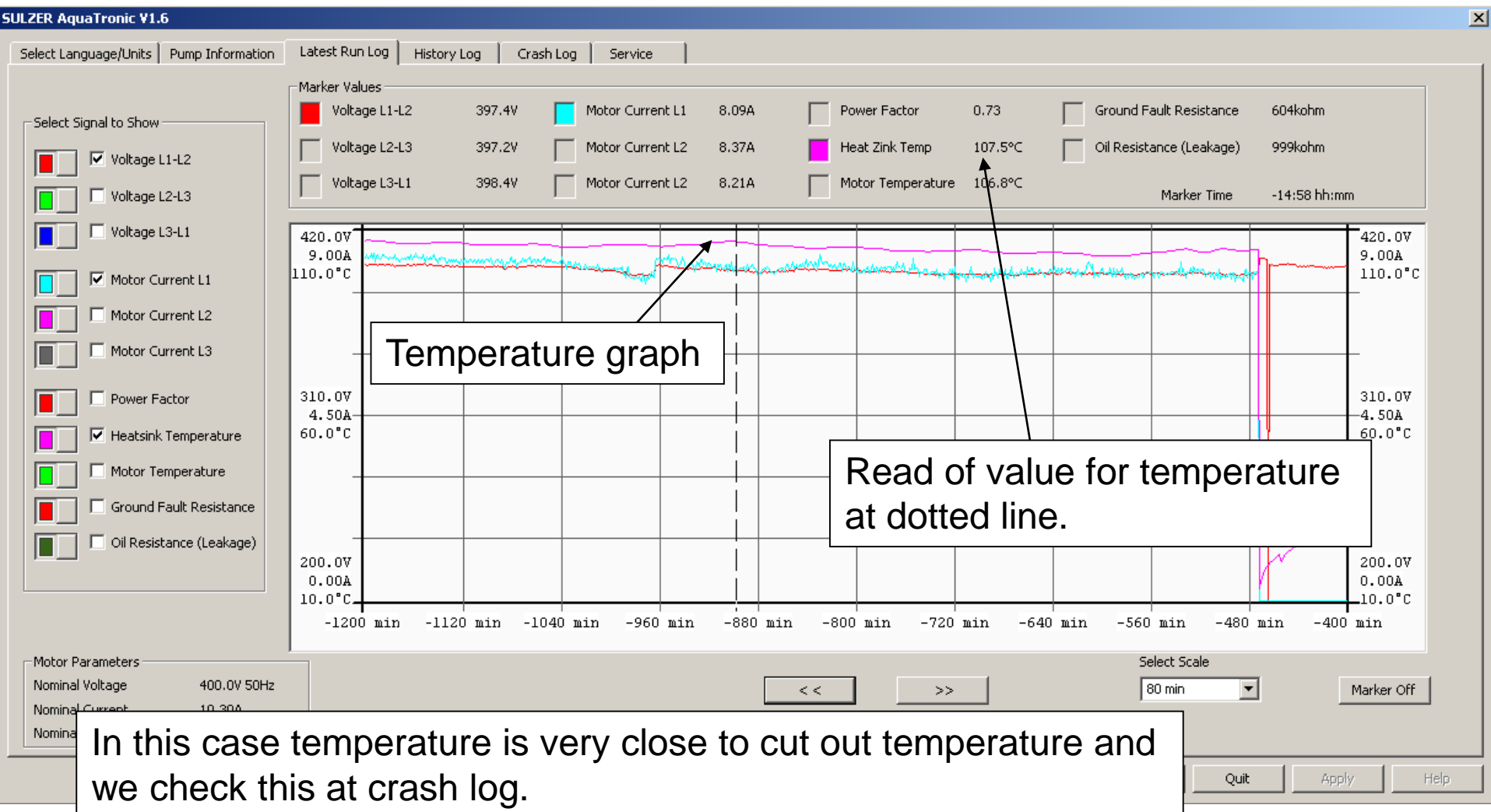

2.5 High temperature in electronics Crash log 12

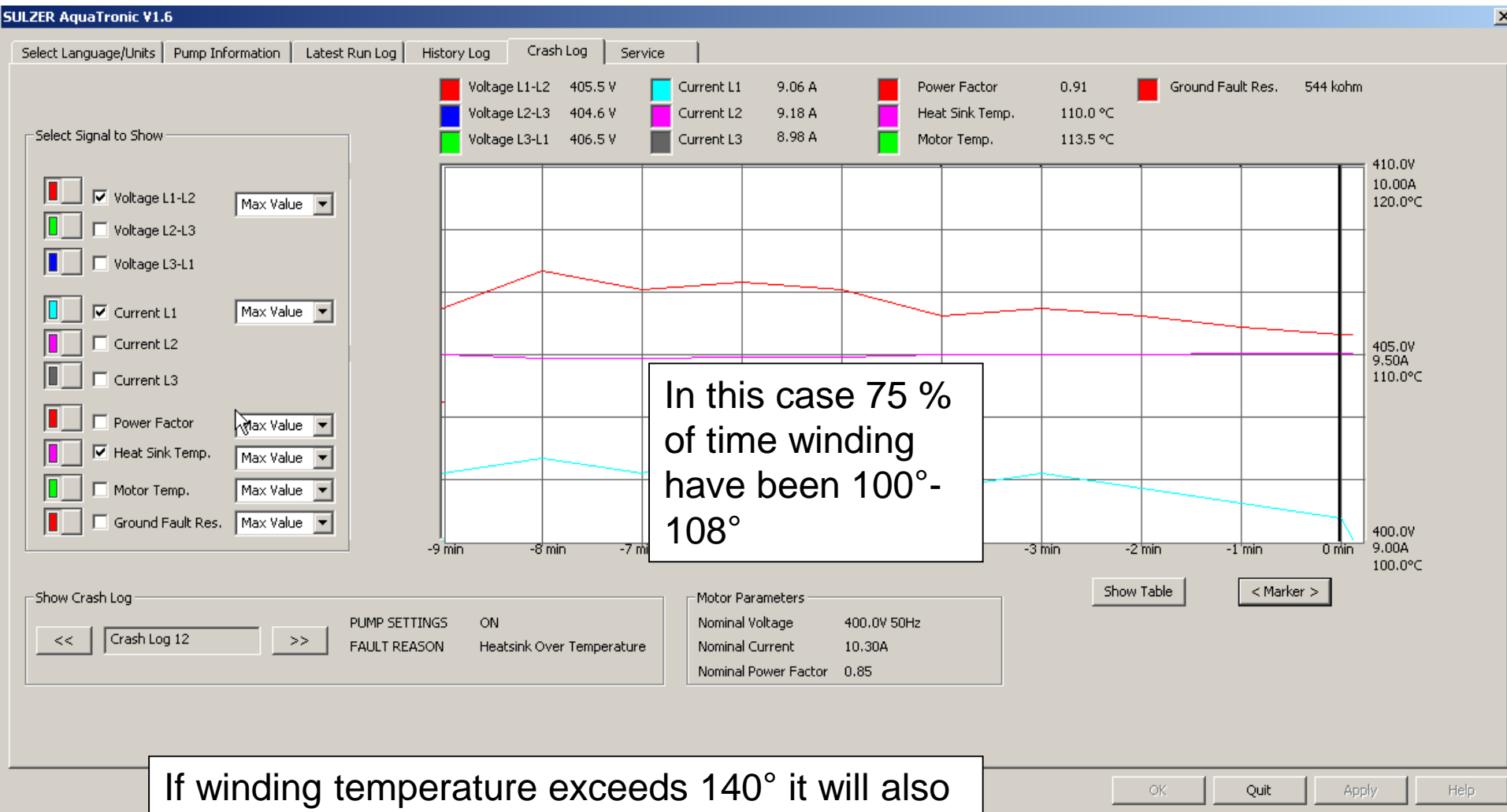

If winding temperature exceeds 140° it will also show in crash log.

2.4 High temperature in winding

2.5 High temperature in electronics

- High temperature in windings and electronics can be caused by
 - High load during long period of time (high SG Specific Gravity of pump media or friction in impeller turning).
 - Bad cooling, if XJS pumps are running long time with low water level (below stator housing) it often results in high temperature in electronics this is measured at the aluminium base plate for the AquaTronic unit used as heat sink.
 - Too hot water is pumped. A maximum temperature for pumped water is 40°C.

2.6 Locked rotor

1. Rotor is locked at start
 - AquaTronic unit is made to restart the pumps 3 times, then try to kick backwards one time and restart once. Thereafter, the pump is stopped with locked rotor.
 - This will show as fallen motor protector on direct started pumps and start time out on soft started pumps.
2. Rotor gets blocked while running
 - On direct started pumps this will cause the motor protector to cut according to cut out curve (page 20) this will take 1-2 seconds.
 - On soft started pumps current will run up to start current for motor which normally is 7-8 times nominal. This is over the accepted limit for Thyristors and AquaTronic units are made to cut off as soon as possible 0.001-0.01 of a second.

2.6 Locked rotor

Locked rotor at start with AquaTronic DS pump. In this case a XJ 50ND.
Nominal amperage 10.3 A. Start current 92 A.

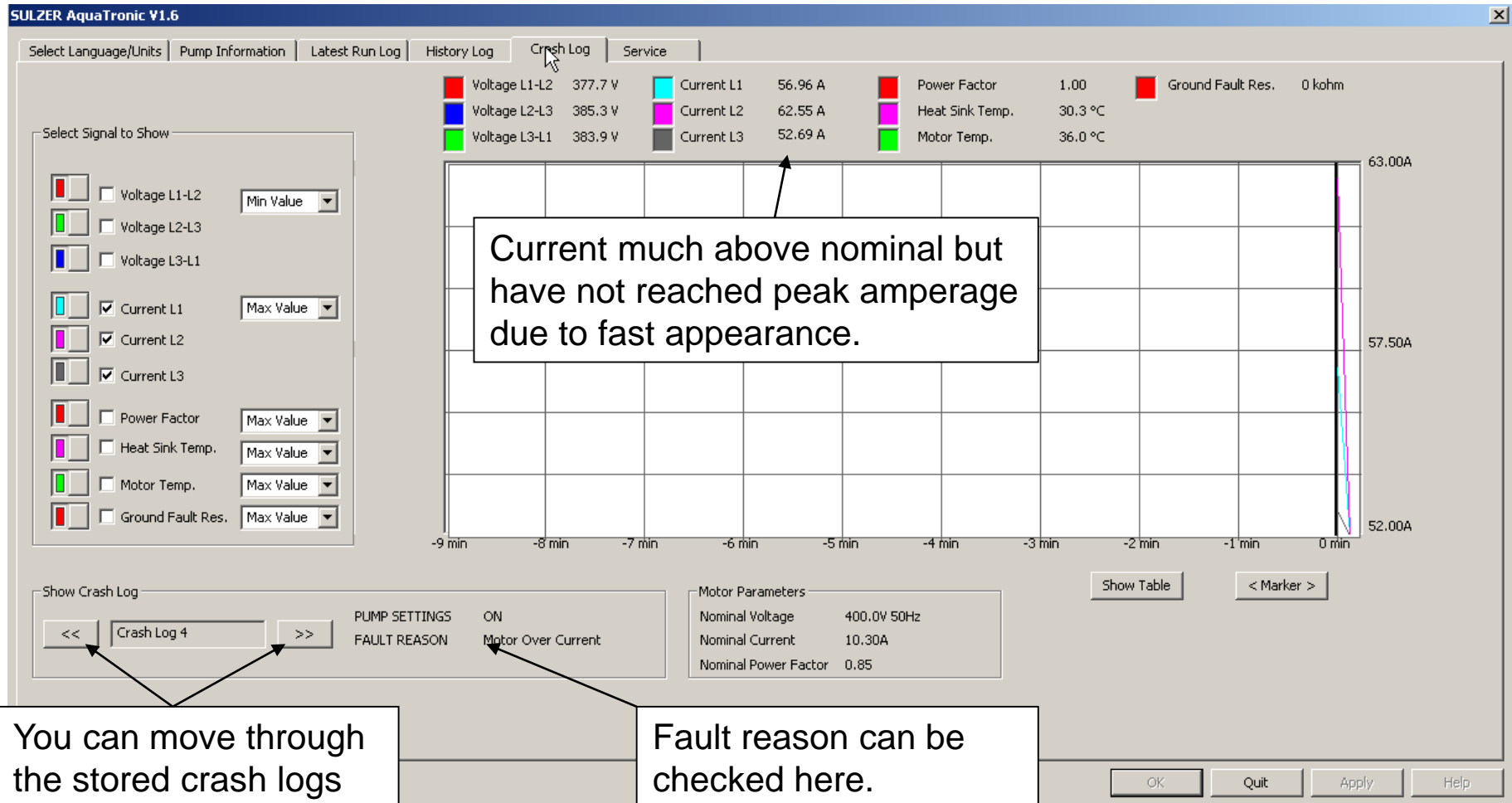

You can move through the stored crash logs here.

Fault reason can be checked here.

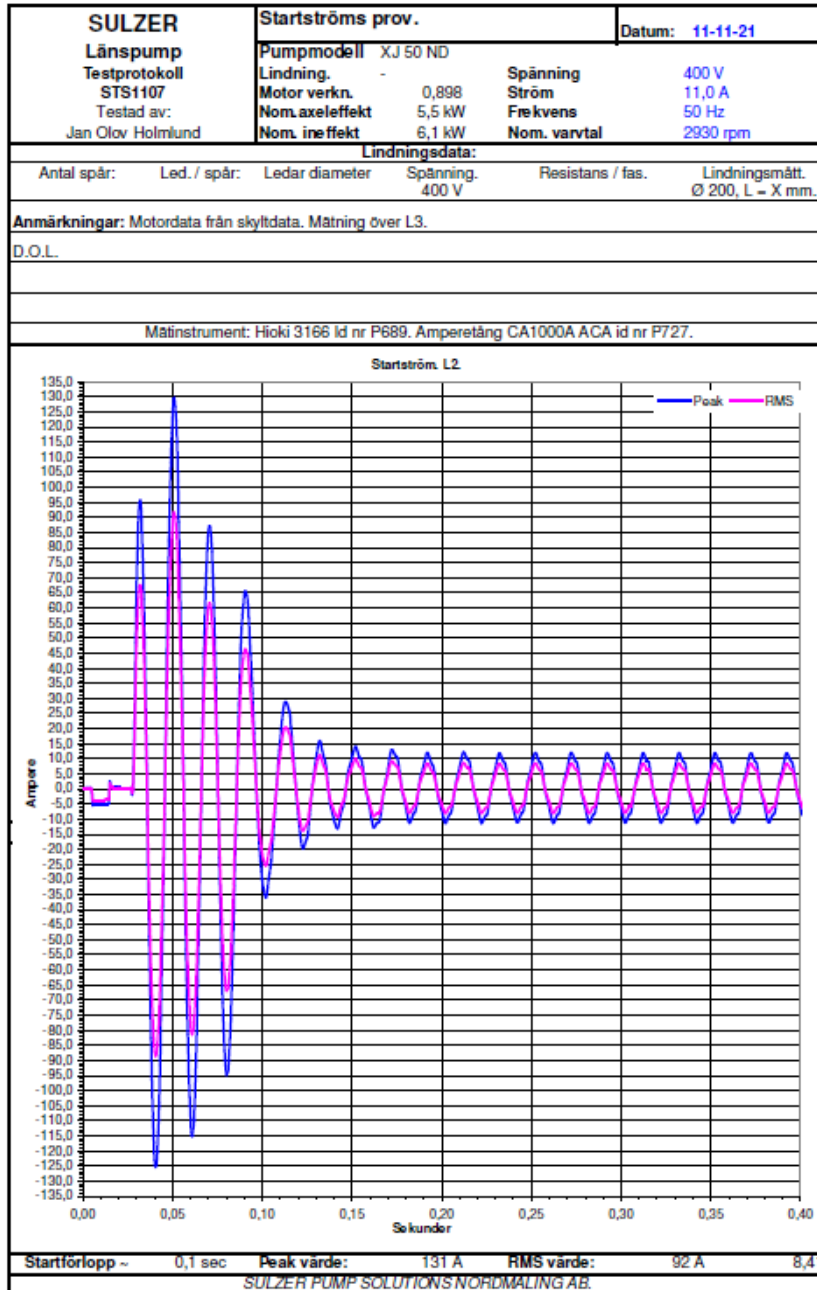

2.6 This shows start sequent of a direct started XJ 50ND. Full start sequence is done in about 0.1 seconds. Measurement in AquaTronic cannot keep the measuring speed like this and the read out will show average values.

2.7 Worn hydraulics

- If hydraulics get heavily worn the power input gets low and pumps that are set on power save mode (off/on) could experience problems as power can be the same as normal snoring and pump will stop as soon as it have started.
- Worn hydraulics can also cause flow to be reduced as far as no water is cooling pump which can cause overheating problems.

Service check

This part is made to speed up normal service.

If these initial tests do not show bad signs we can assume pump to be OK.

1. No fault counters.
2. Earth current below 30 mA (or Ground fault resistance above 100 kOhm).
3. Oil resistance values above 10 kOhm.
4. Run pump and check head against shut of valve.
5. Adjust wear ring if needed according to service manual.

Pump is then ready for new operation.