

SULZER

Sulzer Chemtech

Separation Technology for the Chemical Process Industry



Technology Leadership

The chemical process industry has always been the driving force for Sulzer Chemtech's innovations. In the early 1960's, the stringent requirements for the purification of heat-sensitive fragrances led to the development of the Sulzer Packing BX, which set a new standard for vacuum distillation and led to the development of many other unique products.

Sulzer Chemtech Achievements:

- 1964 BX gauze packing for distillation of heat-sensitive fragrances
- 1977 Mellapak for styrene/ethylbenzene towers
- 1980 Nutter SVG tray for ethanol separation
- 1986 Safety concept for hydrogen peroxide purification
- 1988 Heat pump system for styrene/ethylbenzene towers
- 1992 Crystallization plant for acrylic acid
- 1998 Vapor Permeation Membranes to break solvent azeotropes economically
- 1999 Katapak for the reactive distillation of acetates
- 1999 MellapakPlus for styrene towers
- 2000 Shell HiFi tray for xylene splitters

For classical column operations like distillation, absorption and extraction, and for alternatives such as crystallization, membrane permeation and reactive distillation, we are continuously developing new product ideas to meet the economical and technical objectives of our customers. For numerous applications Sulzer Chemtech provides superior plant performance, improved product quality, increased capacity, and reduced energy demand.

Sulzer Chemtech offers a full range of column internals with trays, structured packing, and random packing embedded in column simulation, process design, basic engineering and field services.

Sulzer Chemtech is a worldwide leading supplier for separation technology, thanks to our customers and the confidence they instill into our products and our capabilities.

From the very first to the very last of our more than 30.000 columns in operation, we have never stopped listening to our customers about their needs. At Sulzer Chemtech, we are eager to learn how we can develop a successful application for your needs.

Industrial Applications from A to Z

Acetates	21
Acetic Acid	14
Air Separation	17
Alcohols	3
Aromatics	4-5
Caprolactam	10-11
Diisocyanates	8-9
Divided Wall Columns	22
Flavours, Fragrances	15
Hydrogen Peroxide	18-19
Oleochemicals	12-13
Pharmaceutical Solvents	20
Styrene	6-7
Tall Oil	16
Terephthalic Acid	14
Vitamins	15

Color index of the diagrams

• Structured packing	
• Trays	
• Random packing	
• Catalyst	
• Mixers	
• Membrane	

Alcohols

Bioethanol:

A source of alternative fuels.

Bioethanol, which can be used as an automotive fuel by itself or mixed with conventional fuels, is made of agricultural products, including waste water.

The use of this renewable energy source as fuel has the benefits of cleaner combustion and lower emissions of carbon dioxide.

Bioethanol is produced through a biological fermentation process, followed by distillation/rectification and dehydration.

Due to the presence of solids this process is known as a fouling service. Sulzer Chemtech has extensive experience in the use of trays for fouling services.

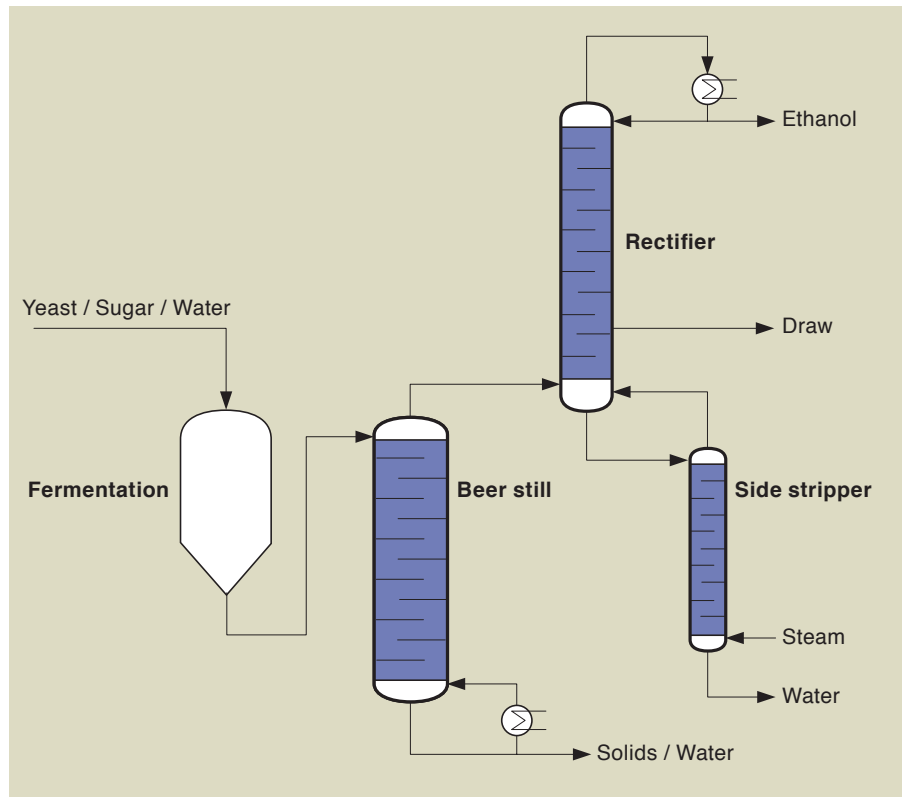

SVG™ Trays for Fouling Services

The SVG fixed valve is perfect in fouling services:

- The lateral vapour release from the SVG allows for a cleaning action on the tray deck, which minimizes fouling
- The SVG has a flexible operating range due to the different valve lifts available
- The fixed valve trays are very stable from a mechanical point of view
- The valve is situated such that it operates parallel to flow, therefore no inlet bars or inlet weirs are required
- The position of the valve is such that the liquid will have no vapour obstructions as the liquid flows across the tray

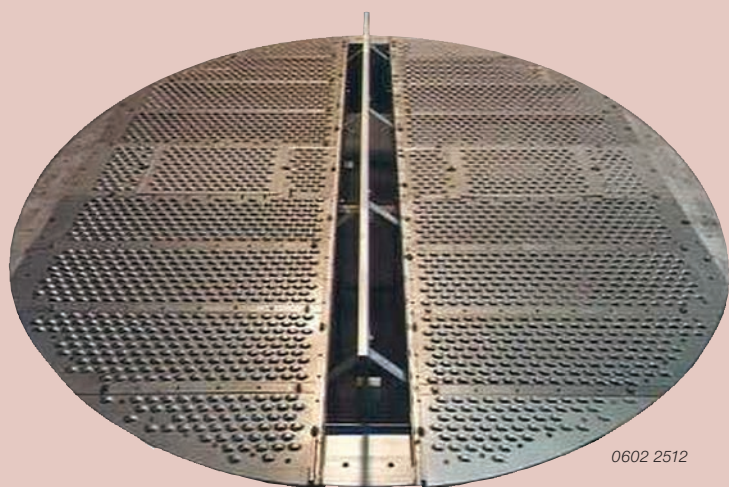

Aromatics

Benzene- Toluene- Xylene (BTX) Aromatics

Aromatics are produced in large quantities in catalytic reforming. They can be converted and recovered by extraction, crystallization and distillation in order to maximize yields of desirable products such as benzene, toluene and xylene.

In a complete aromatic unit, a variety of columns with trays are present. Sulzer has experience in applications with columns with a diameter of 0.7 up to 10 meters.

Shell Calming Section™ and Shell HiFi™ trays are successfully being used in aromatic duties like the BTX recovery section.

Xylene Separation

P-xylene can be economically separated from m-xylene through crystallization.

With Sulzer Chemtech's static crystallization process, it is possible to produce p-xylene with a purity of 99.9% and m-xylene with a purity of 99.5%.

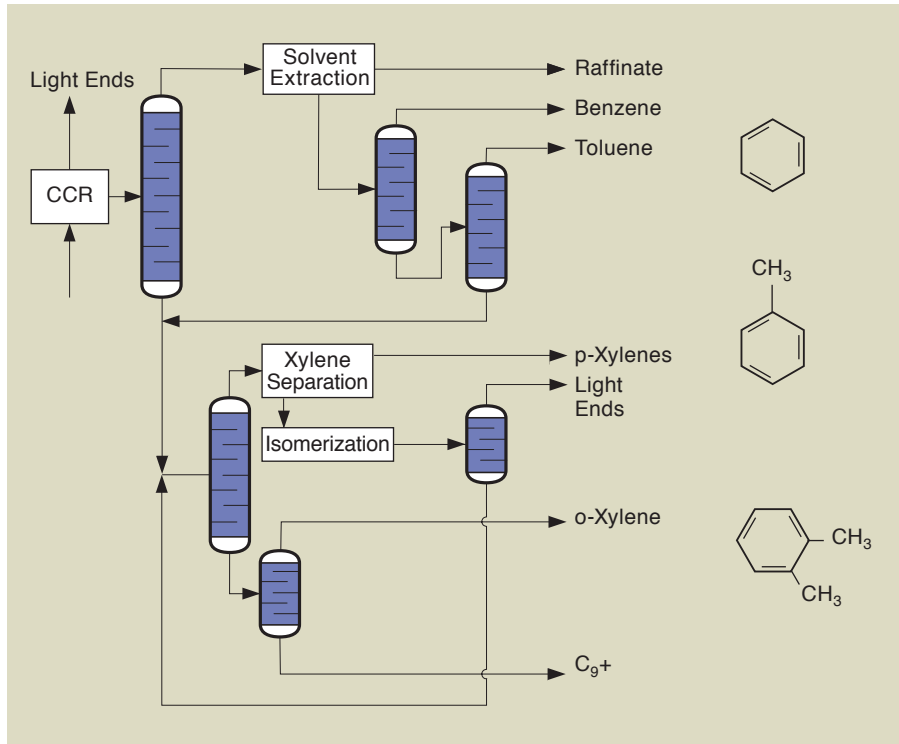

Shell Calming Section Trays

- Maximizes bubbling area
- Highest jet flood and vapor handling capacity
- Long flow path length
- High efficiency
- Available in boltless construction
- Minimum installation time
- Can use many types of bubblers (sieves, valves, fixed valves, etc.)
- Small tray spacing to provide maximum stages
- Several hundred columns in operation

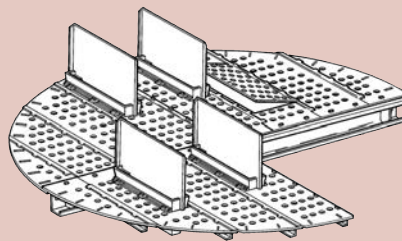

0602 2513-1

SMVP Extraction Packing:

For revamping existing columns for capacity/efficiency increase:

- Increase of viscosity index
- Increase of thermal/chemical stability of the lube oil



0682 2064

Nitrochlorobenzene-Isomers (NCB)

Similar to other isomer separation processes, the separation of NCB-isomers requires multiple theoretical stages. In addition the heat sensitivity of these substances creates further difficulties in the design of distillation columns, thereby necessitating the use of structured packing like the Sulzer BX and Mellapak.



Mellapak 250.Y

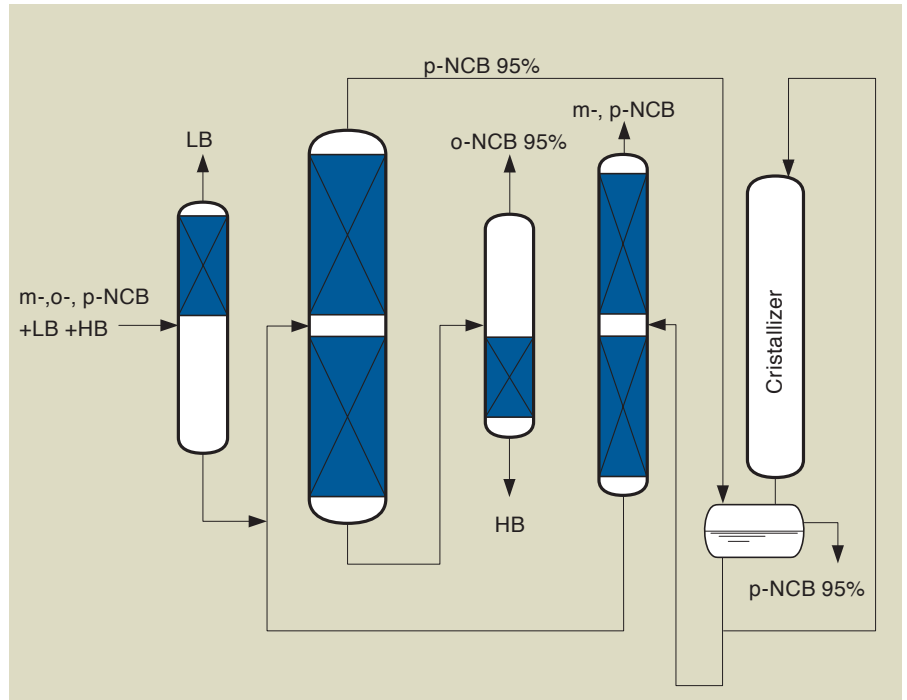

The low pressure drop of our structured packing offers a strong advantage to avoid the temperature limits of the explosive mixtures.

The combination of distillation with a melt crystallization create further advantages for the product purity.

Dichlorobenzene-Isomers (DCB)

The separation of DCB is maximized by the use of extractive distillation.

With the optimal entrainer, the relative volatility (α -value) can be increased, resulting in more economical columns.

Sulzer Chemtech has extensive experience in the design of trays, packing and internals for extractive distillation columns such as for dichlorobenzene, dichlorotoluene, and for the separation of aromatics from non aromatics.

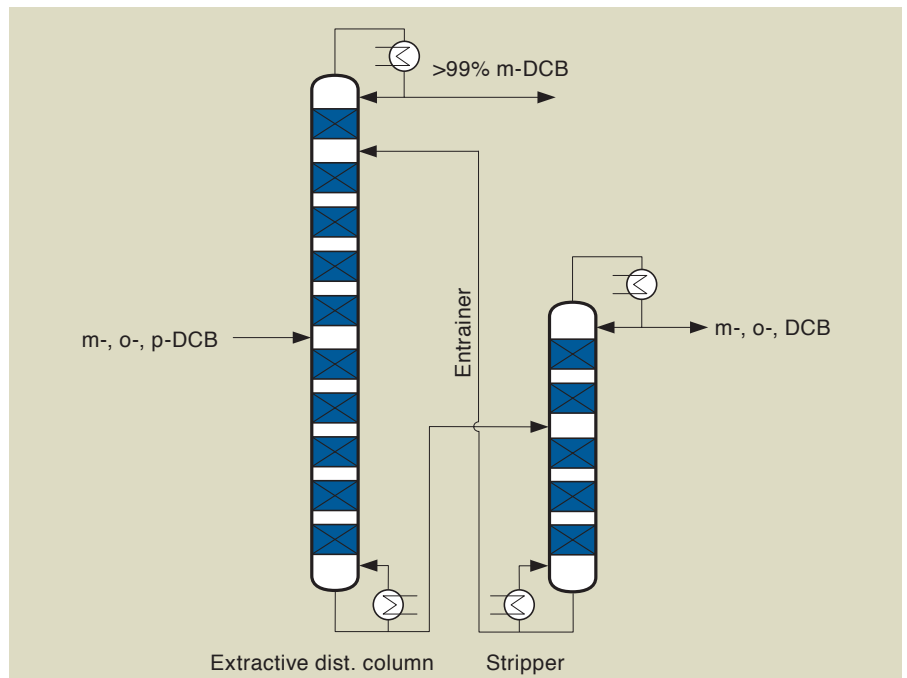

Styrene - Leadership in Distillation and Mixing Technology

Styrene Monomer Purification

Structured sheet metal packings have been in commercial use since the mid 70's with ever growing areas of application due to high separation performance and low pressure drop. Today more than 100 columns for styrene monomer distillation have been equipped by Sulzer Chemtech with structured packing (representing 70% of the world capacity).

Drivers for structured packing towards mass transfer trays

- Prevention of polymer formation because of reduced pressure drop leading to low bottom temperatures
- Reduction of inhibitor consumption because of reduced mean residence time and smaller residence time distribution
- Increase in capacity, yield and purity
- Energy savings by increasing the number of theoretical stages and Sulzer heat pump technology

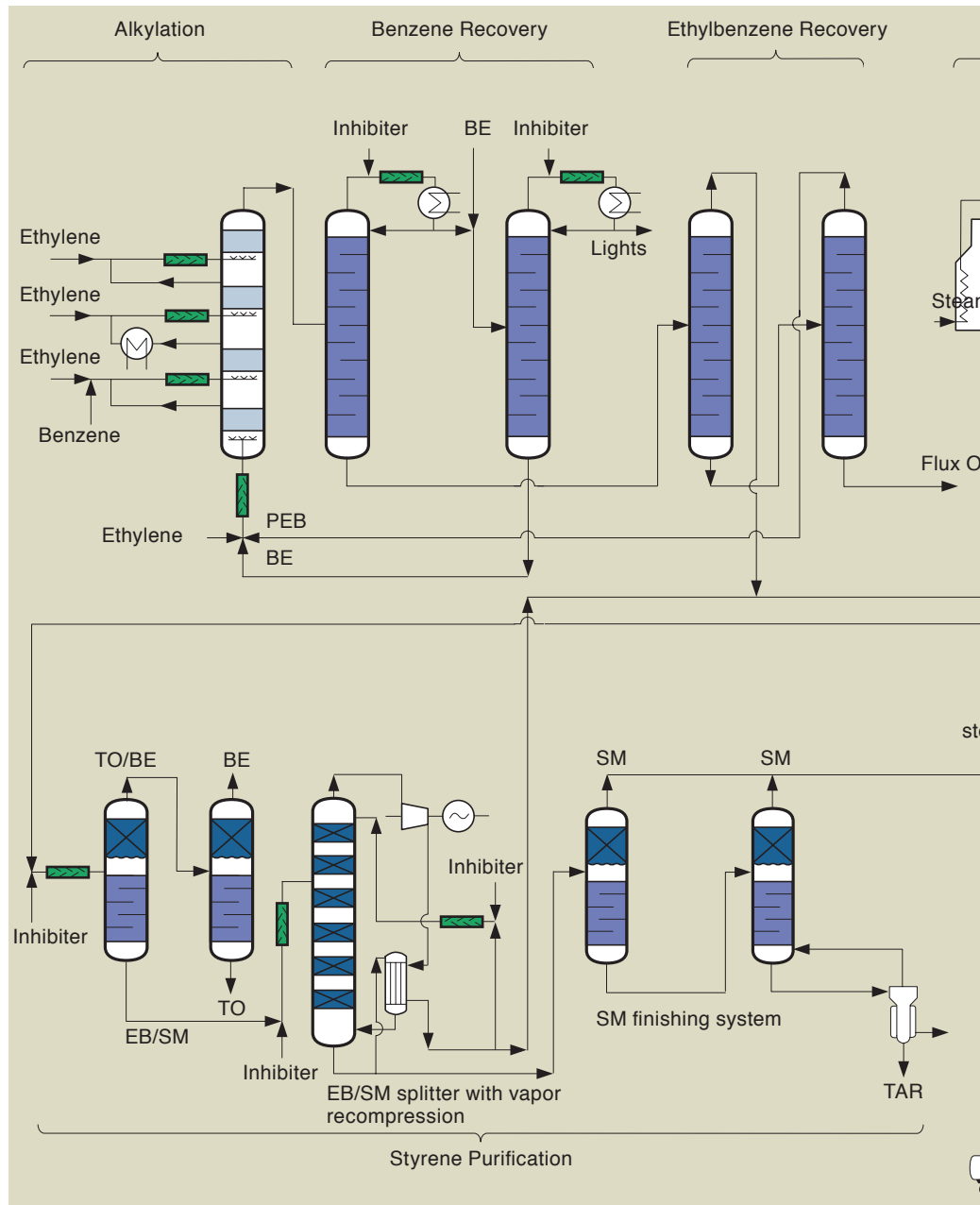

MellapakPlus - A New Generation

- MellapakPlus represents the newest, high-capacity structured packing generation. In addition to the above mentioned advantages MellapakPlus offers the following benefits for styrene distillation:
 - Additional 30 - 50% capacity
 - Remarkable lower pressure drop compared to conventional structured packing

- Lower fouling risk by smooth and steady change of gas flow direction and reduced local liquid holdup accumulation at the intersection between two layers

The performance of MellapakPlus is confirmed by Fractionation Research, Inc. (FRI) and more than 15 columns for styrene purification are in operation with MellapakPlus around the world.

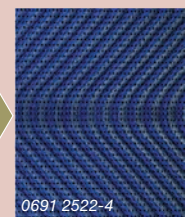
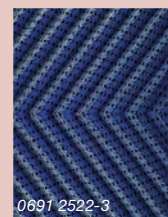

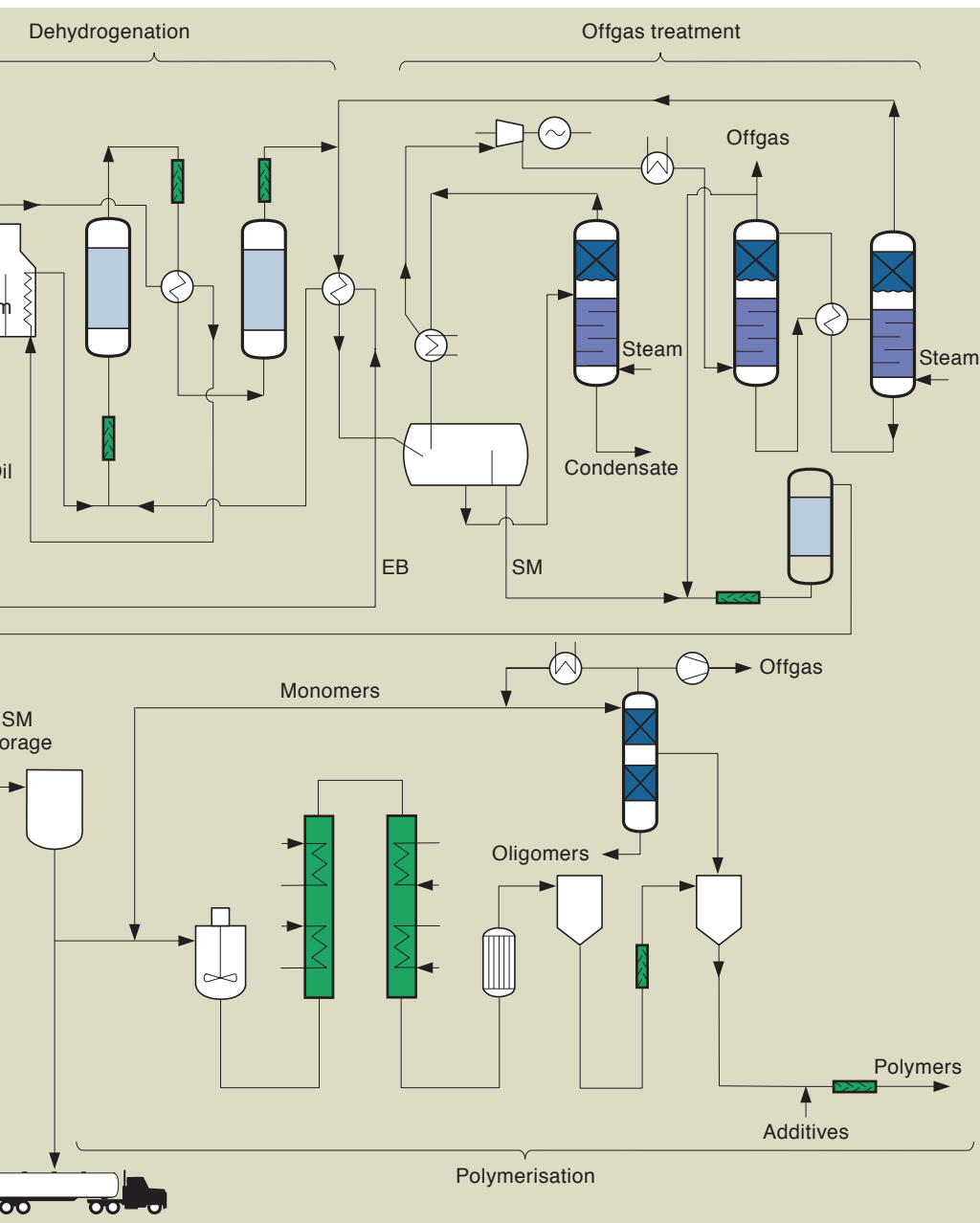

Sulzer / Shell Tray Technology

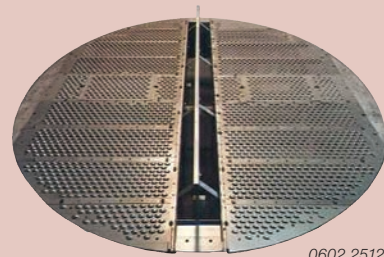

0602 2512

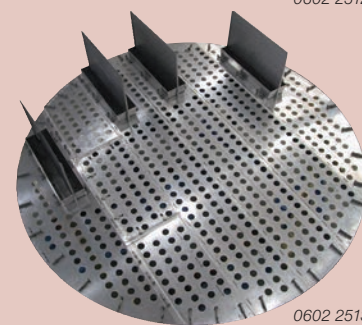

0602 2513-2

Separation Trays for your Ethylbenzene Recovery

Conventional trays

- Sieve tray
- Valve tray
- Sulzer SVG / MVG tray
- Bubble cap tray
- Dualflow tray
- Baffle tray

High performance trays for revamps

- Sulzer Vortex tray
- Sulzer MVGT tray
- Shell Calming Section / HiFi tray
- Shell Consep tray

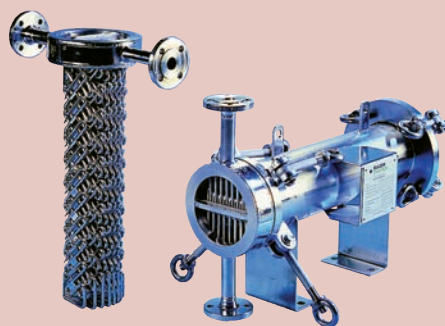

0699 2706-3

Sulzer SMR Static Mixer Reactors

They are installed in more than 15 styrene polymerisation plants, where they provide:

- High heat transfer in small volume
- Narrow residence time distribution
- Low pressure drop



0691 2724-3

Sulzer Static Mixers SMV

are installed in the ethylbenzene dehydrogenation reactor section of more than 50 plants. They reduce the temperature difference down to ± 2 °C at reactor inlet with minimum pressure drop.

Diisocyanates - Purification Technology for all Demands

Diisocyanates MDI & TDI

Toluene diisocyanate (TDI) and methylene diphenyl diisocyanate (MDI) are the most commonly used source for polyurethane production (foams for insulation, furnitures, automotive industry).

Toluene Diisocyanate

All common processes to produce TDI involve purification units for preproducts like dinitro toluene (DNT) and toluene diamine (TDA). Removing impurities of hydrochloric acid, phosgen and solvent is similar to the process involved in the production of MDI. Since TDI has to be purified to market specifications, Sulzer Chemtech offers a wide range of technologies to meet the customer's specific requirements. More than 25 distillation services and two crystallization units with Sulzer Chemtech technology are in operation.

Methylene Diphenyl Diisocyanate

Beside MDA distillation and the different kinds of absorbers and strippers for phosgenation, we are focused on the purification MDI at its final stage. MDI has the tendency during the purification process to form dimers resp. polymers at high temperatures and residence times. Therefore, low pressure drop and few liquid holdup are decisive criteria for the final product quality.

MDI Process

Acid Catalytic Condensation

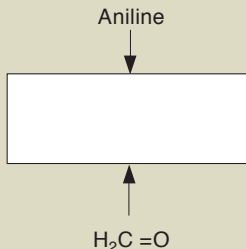

MDA Purification

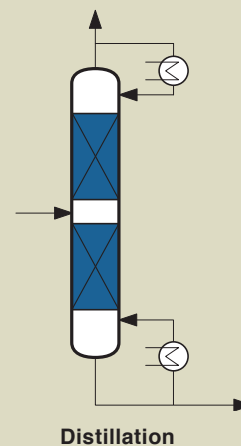
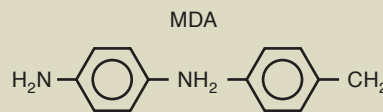

Your Advantages with Sulzer Chemtech:

- MellapakPlus the packing with lowest pressure drop
- Comprehensive experience with liquid distributors
- Safe column design based on pilot tests
- Performance guarantee
- Many industrial references (> 35)
- Knowledgeable on heat exchanger design

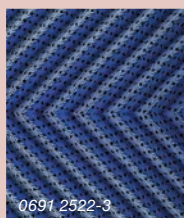

Mellapak

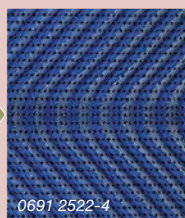

MellapakPlus

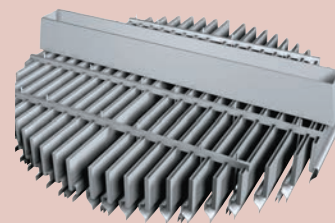

Splash plate distributor



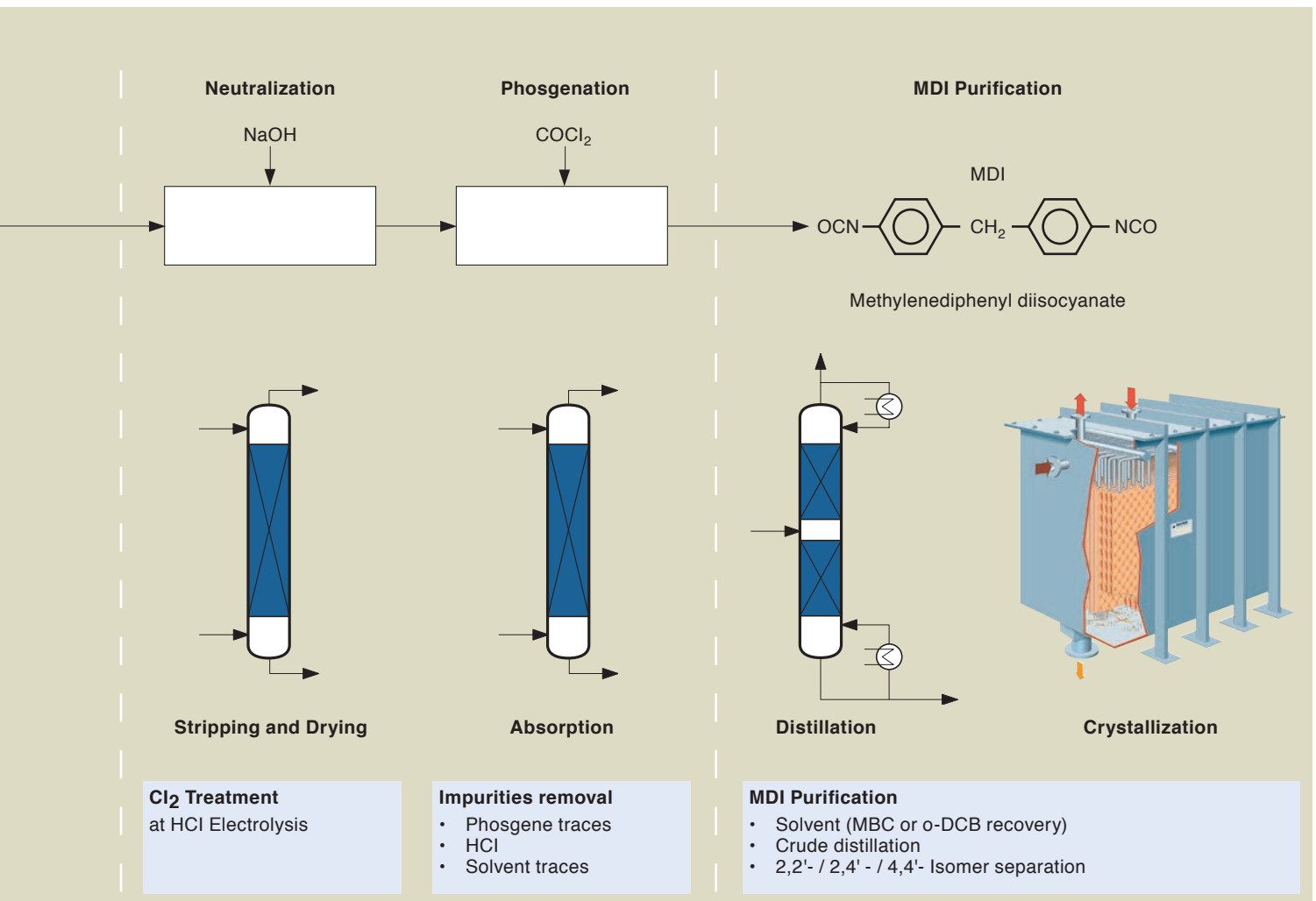

Absorption & Stripping

Sulzer has many years of experience in stripping and drying columns for the treatment of chlorine and hydrochloric acid, as well as the removal of phosgene and solvent traces by absorption. More than 100 hydrochloric acid absorbers are in operation with Sulzer Mellapak.



Mellapak in plastic

0682 2021

Distillation of MDI

Paying attention to the following key features will lead to a successful column design:

- Pressure drop
- Bottom temperature
- Liquid holdup (residence time)
- Plugging risk of distributor
- Dimer, polymer formation
- Product color

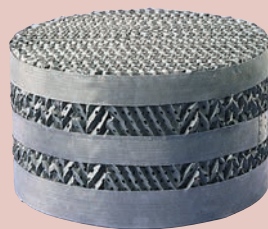

BX gauze packing

0682 2017

Crystallization of MDI

Crystallization is the most gentle way to purify MDI for the polyurethane market, a process with high yield at low energy cost. The maximum temperature required is approximately 40 °C. Depending on feed and product specification, crystallization is a very competitive technology compared to distillation. However, Sulzer Chemtech provides both technologies in a combination leading to a maximum of plant flexibility in terms of capacity, product yield and quality.

Caprolactam - Gentle Purification with Sulzer Chemtech Technology

Sulzer Services for Caprolactam Plants

- Column simulation and design
- Feasibility studies for debottlenecking
- Extended performance guarantee
- Troubleshooting
- Column scanning
- Pilot testing
- Field supervision
- Installation

Purification of Cyclohexanone

The main route (85% of world capacity) for conventional production of caprolactam is based on phenol or cyclohexane producing cyclohexanone, which is converted via cyclohexanone oxime to caprolactam.

For the purification of cyclohexanone today, most distillation columns are equipped with structured packing to handle temperatures below 90 °C. MellapakPlus is Sulzer's latest, advanced technology for this separation to realize purities >99.95% wt. cyclohexanone.

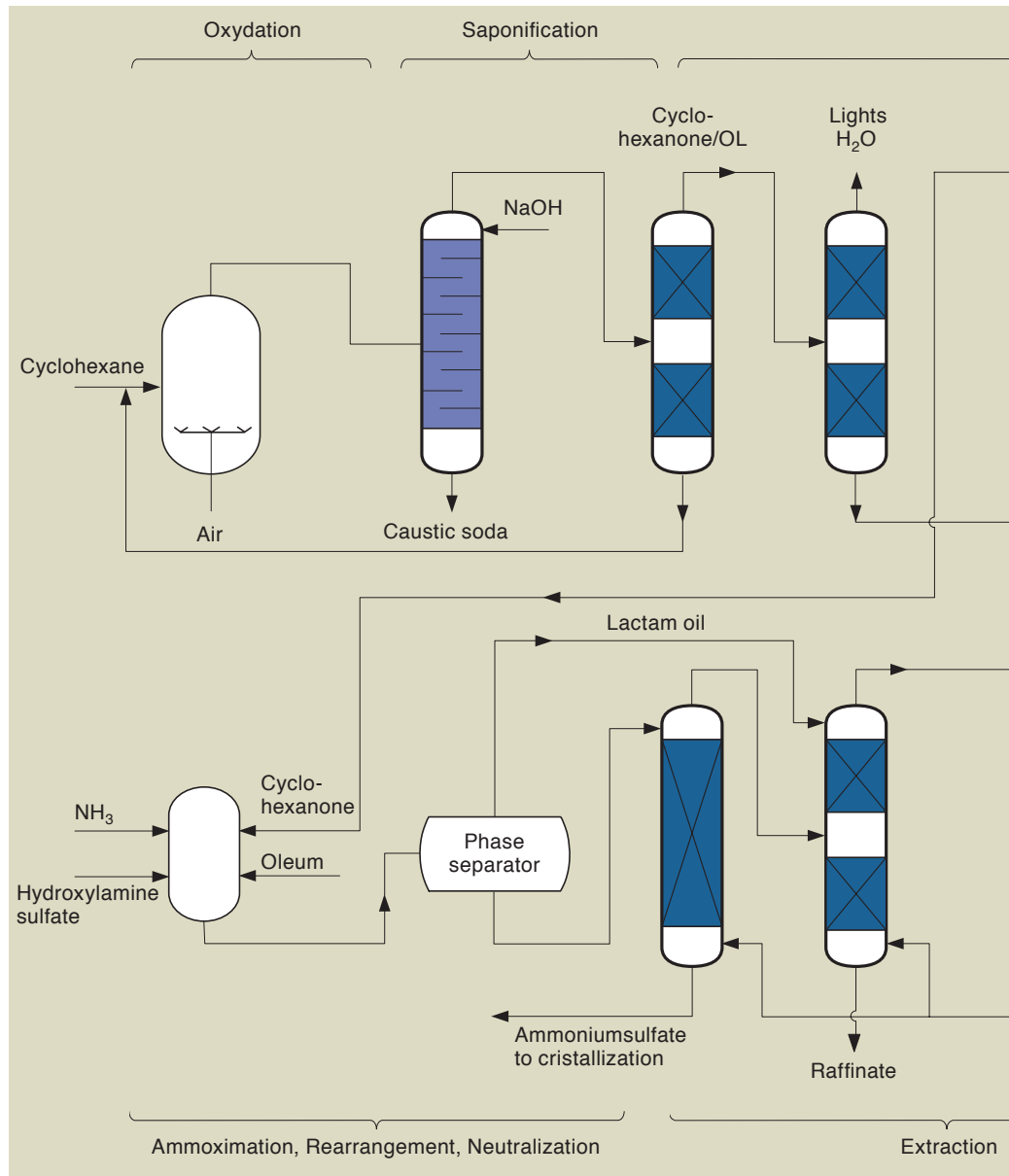

Structured Packing Drivers

- Higher capacity (small columns)
- Low pressure drop for operating with advantageous equilibrium
- Fewer holdup
- Higher separation efficiency leading to low energy consumption
- Large turndown flexibility

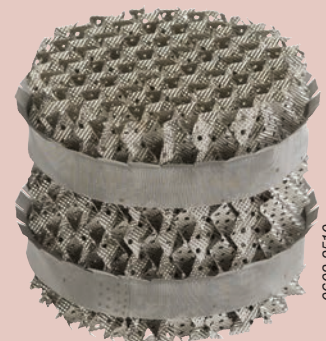

0602 2510

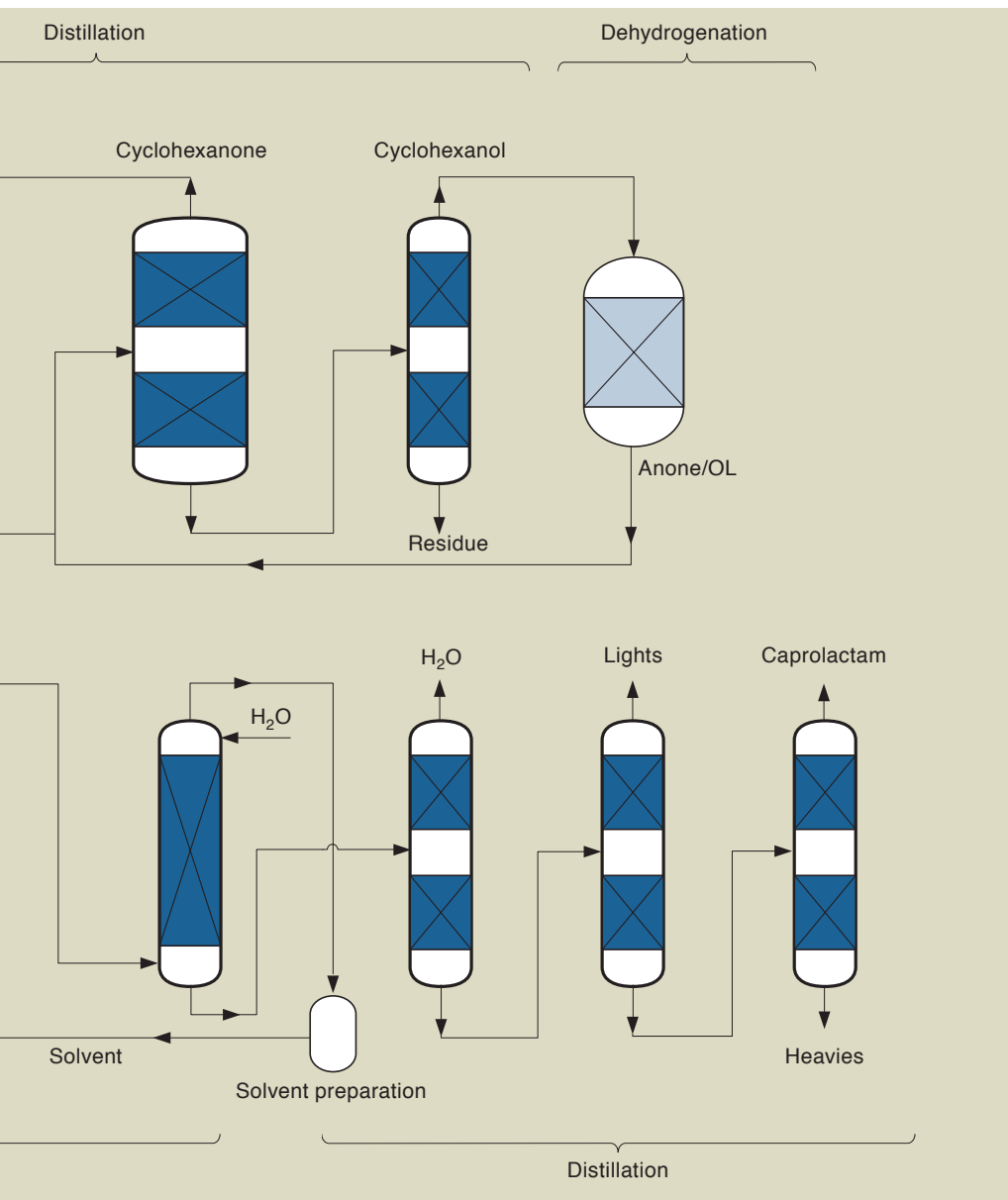

Purification of Caprolactam

Caprolactam is very heat sensitive. To prevent decomposition of the product, distillation columns for the separation from heavy and light boiling impurities must be operated at temperatures below 140 °C. The range of admissible impurities is some ppm. Product color is also an important quality feature.

This results in low vacuum (2-20 mbar) operating column conditions, where

- Low pressure drop
- Low liquid holdup
- Low mean residence time
- Narrow residence time distribution are decisive for the success of our customers

Fractional Crystallization equals Premium Quality

Crystallization is used as final purification step (topping of distillation). It is an effective and competitive technology to produce a premium quality product that is environmentally safe and benefits from high flexibility at a low energy and maintenance cost. Sulzer offers proprietary falling film technology for caprolactam purification.

Distillation: Our Success

- Sulzer offers the lowest pressure drop per theoretical stage in the market with MellapakPlus
- Many years of experience in equipment design (columns, heat exchangers, control systems)
- Columns with BX, Mellapak and MellapakPlus at all main caprolactam producers
- More than 20 distillation units with Sulzer column internals in operation

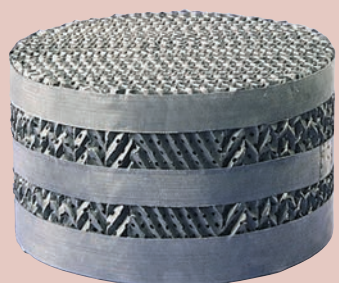

Oleochemicals - Step into a growing Market with Sulzer Chemtech

Sulzer Chemtech benefits from decades of experience distilling oleochemicals (fatty acids, fatty alcohols, fatty acid esters). Pilot distillation experiments have been performed in Winterthur (Switzerland) and in-house vapor-liquid-equilibrium (VLE) parameters are available. It is estimated that today more than 500 industrial columns, utilizing Sulzer Chemtech structured packing and internals, are in operation.

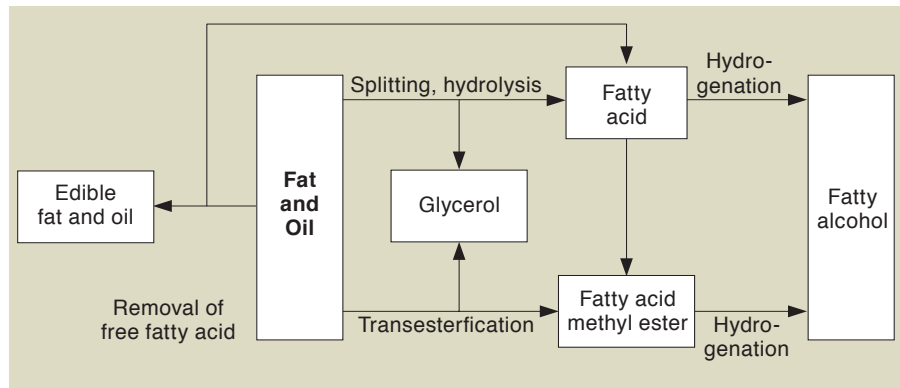

Overview of Fat and Oil Processes

Fatty Acid Distillation

Fatty acids are saturated and unsaturated aliphatic carboxylic acids with carbon chain length in the range of C_6 up to C_{24} .

Example: palmitic acid, $CH_3 - (CH_2)_{14} - COOH$

Knowledge of the chemical and physical properties of fatty acids is one of the basic prerequisites for industrial manufacturing and technical applications. Thermodynamic data are necessary for the calculation of heat transfer and thermal separation.

Sulzer Chemtech has the know-how, the extensive experience and the structured packing with internals to ensure the most gentle distillation of fatty acids.

Further specialties in this field are:

- Multipurpose fatty acid distillation plants
- Separation of $C_{18}' / C_{18}'' / C_{18}'''$
- Liquid / gas side product draw-off
- Pump-around condensers
- Steam generation (condenser heat recovery)

Fatty Alcohol Distillation

Fatty alcohols are aliphatic alcohols with carbon chain lengths between C_6 and C_{22} :

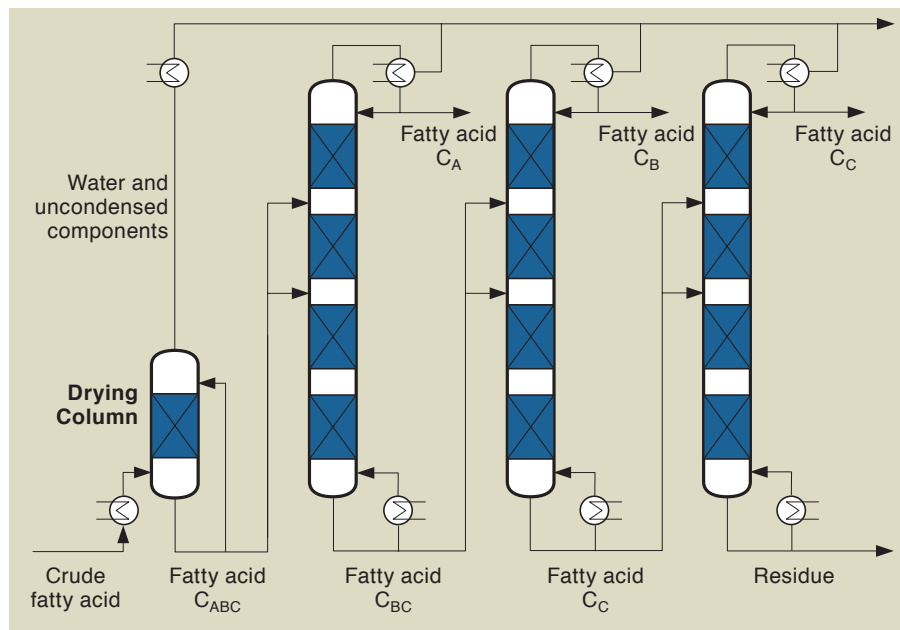
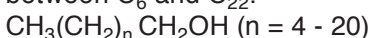

Multipurpose Fatty Acid Distillation Plant

In the oleochemical production of fatty alcohols, molecules never have a uniform carbon chain length. For purification and quality improvement, the fatty alcohol mixture has to be distilled. For this separation and purification, the same high technical demands are required as for the fatty acid distillation.

Glycerol

Glycerol ($C_3H_8O_3$), 1,2,3-propanetriol, commonly known as glycerin, is the simplest triol. It is obtained as a byproduct during the conversion of fats and oils to fatty acids and fatty acid methyl esters. Depending on a customer's

requirements, glycerol can be purified up to:

- Technical grade by atmospheric drying
- Pharmaceutical grade by vacuum distillation

Distillation of oleochemicals requires attention to the following key features:

- High vacuum
- Low pressure drop
- Low bottom temperature
- Minimum holdup
- Short residence time

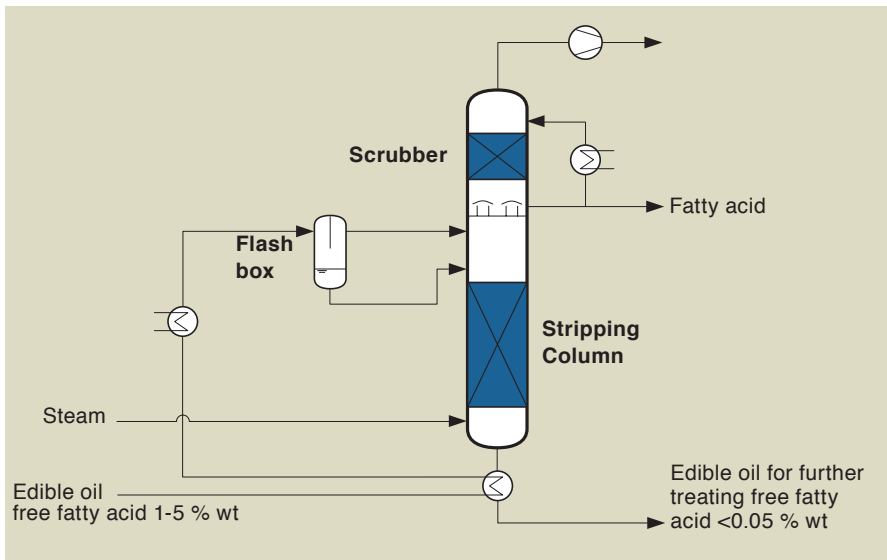

Free fatty acid removal for edible and oil treating

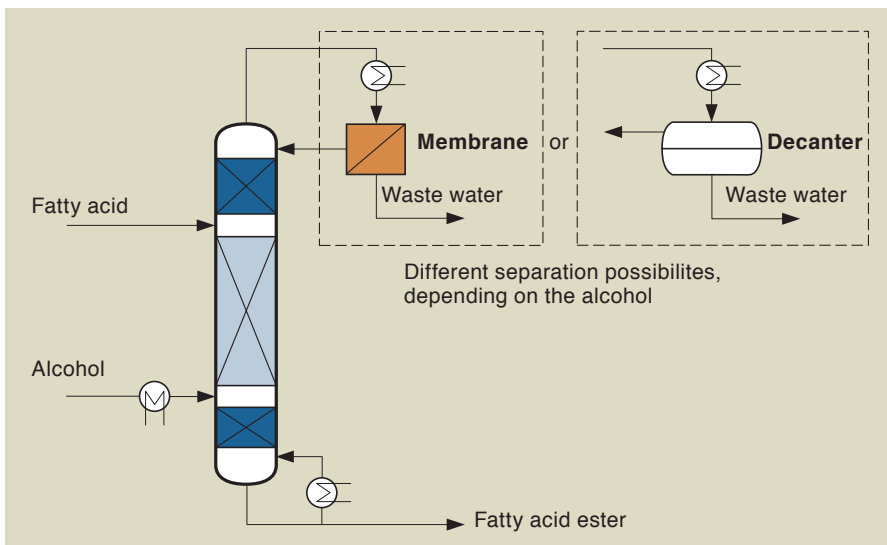

Fatty acid esterification plant with Katapak and MellapakPlus

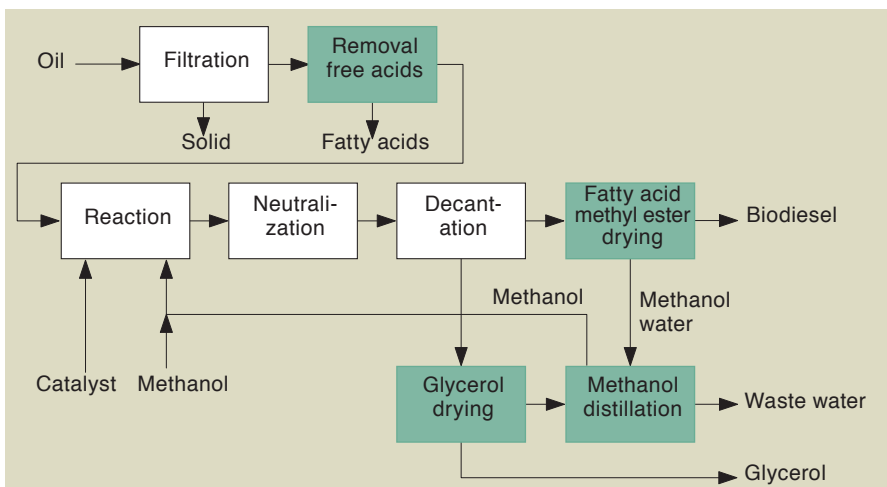

Biodiesel process

Edible Fat and Oil Deodorization

Through the use of structured packing, free fatty acids present in vegetable oils must be removed with extreme care. The columns operate at a very low vacuum so that it is of immense importance that the pressure drop in the stripping column is also low. In comparison with a conventional apparatus, steam consumption falls by 70%.

Fatty Acid Esterification by Reactive Distillation

Reactive distillation technology advantages:

- Shift of the chemical equilibrium and increase of reaction conversion by simultaneous separation of products
- Suppression of side reactions
- Utilization of heat of reaction for mass transfer

Reactive distillation applied to fatty acid esterification:

- Continuous process with smooth operating conditions resulting in constant product quality
- Short residence time at moderate temperatures avoids product degradation
- No separation, neutralization or recycling of catalyst necessary
- Direct recycle of surplus alcohol
- 45% lower energy consumption compared to conventional batch process

Biodiesel

To be powered by a renewable fuel is not a dream any longer. The biodiesel process overview shows the field of Sulzer Chemtech activities in the green boxes.

Purified Terephthalic Acid / Acetic Acid

Purified terephthalic acid (PTA) is mainly used to create polyester fibers (75%) and polyethylene terephthalate (PET) and it is manufactured through the catalytic liquid phase oxidation of p-xylene in acetic acid in the presence of air. This exothermic process reacts to produce water, which can be removed by a solvent recovery system. The main component of this solvent recovery system is the dehydration tower which separates acetic acid and water.

Sulzer Chemtech has been equipping new columns and revamping existing units for many years. We are able to handle commonly used materials for this application, in addition to specialized materials such as titanium or zirconium.

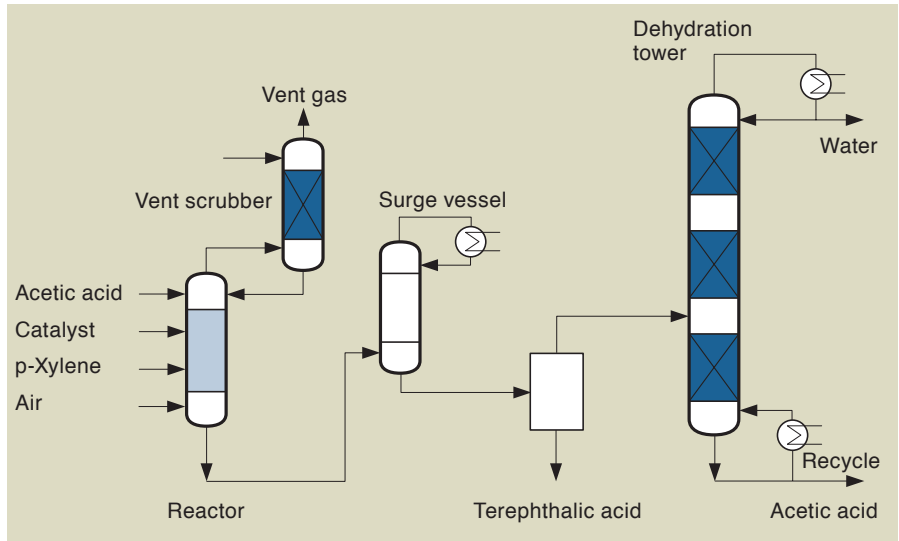

Welding device for special materials



Round valve trays RV-I

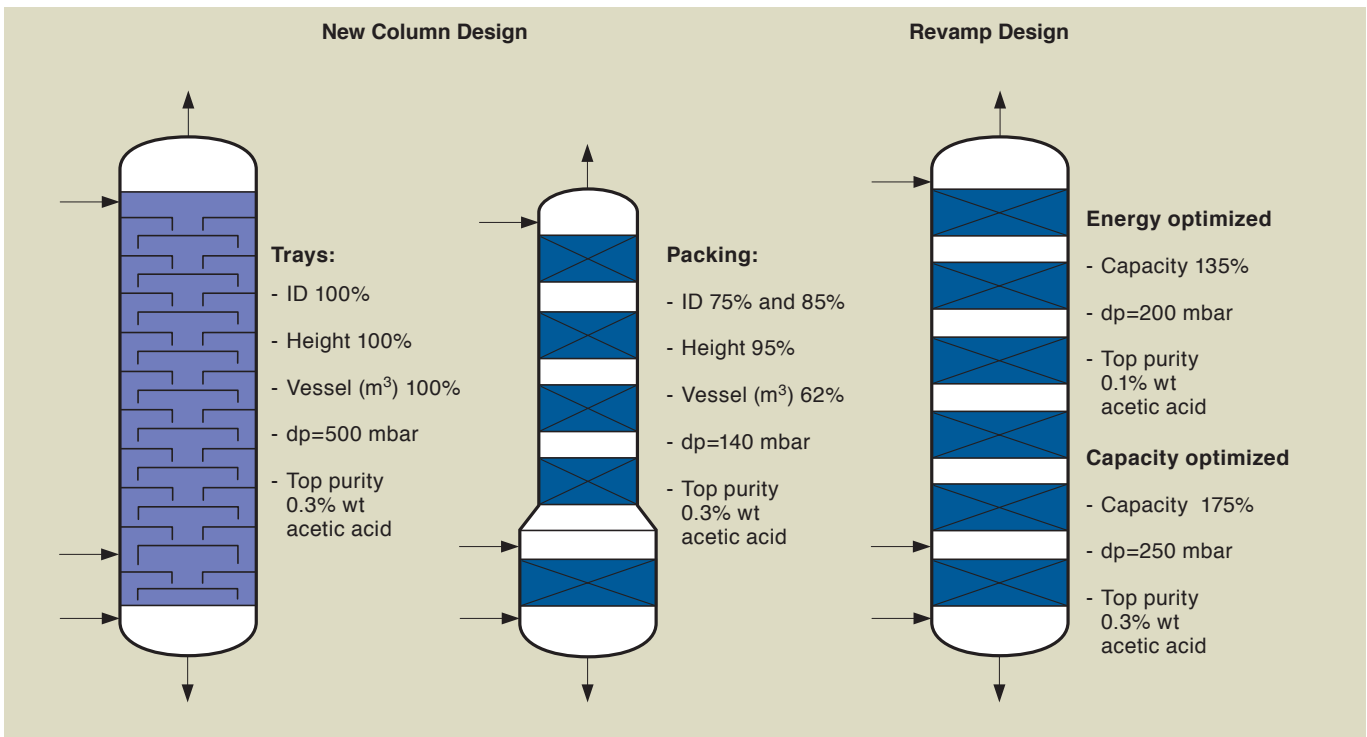

Flavors, Fragrances and Vitamins - Advanced Distillation Technology at its Best

Flavors, fragrances and vitamins vary from highly complex mixtures to single chemicals. Most of these products are temperature sensitive with close boiling points. Thus, a high number of stages in conjunction with a low pressure drop is needed to achieve successful outcomes. Sulzer gauze packing types BX and CY have been used for approximately 40 years

to distill highly sensitive products such as flavors, fragrances and vitamins. Now more than 300 industrial columns are in operation for the production of:

- Citral
- Citronellol
- Eugenol
- Limonen
- Menthol
- Pinene
- Tocopherol
- And many others

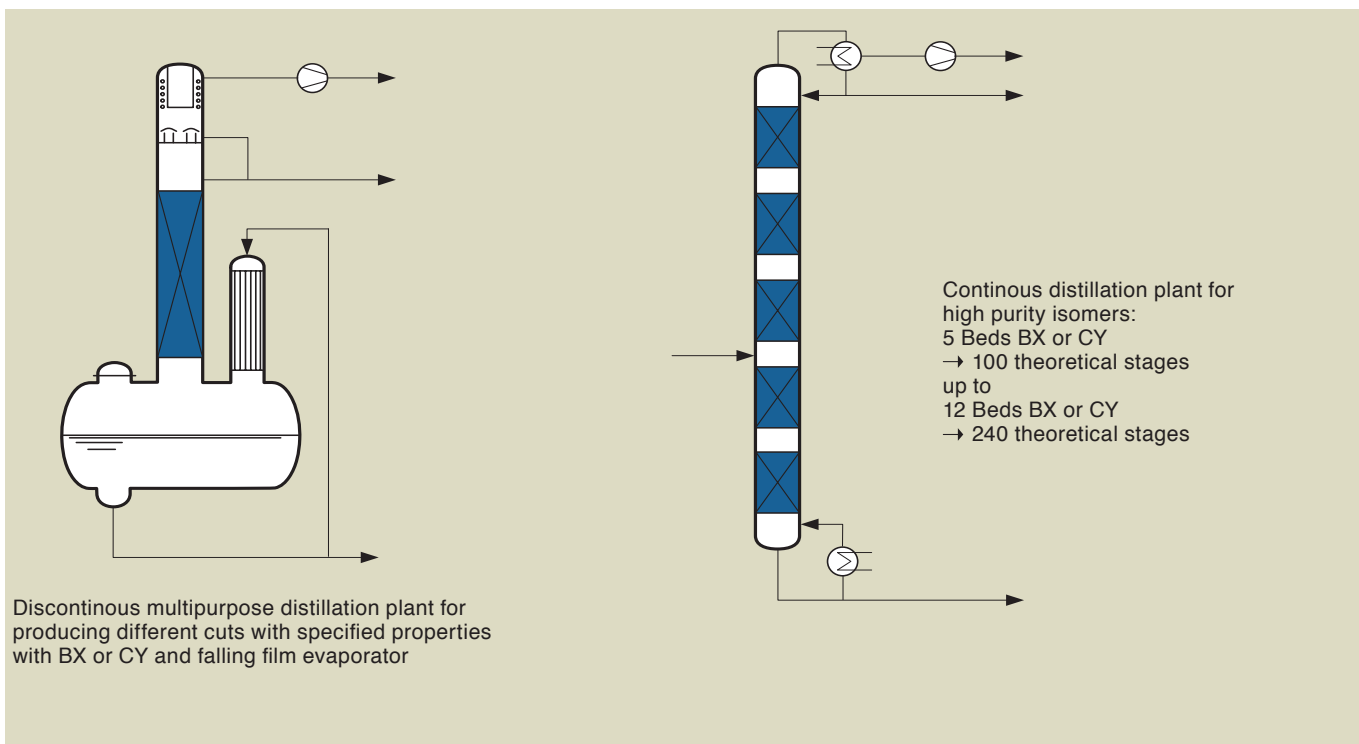

Sulzer Chemtech Gauze Packing Type BX and CY Advantages:

- Low pressure drop per theoretical stage
- Low liquid holdup per theoretical stage
- Low packing height per theoretical stage
- Low intermediate fractions due to a very low holdup

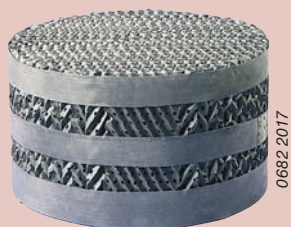

Mellacarbon™

Combines all the advantages of a gauze packing with the corrosion resistance of pure carbon



Tall Oil - Sulzer Chemtech

Experience and Knowledge - a Winning Combination

Tall oil is an oil from pine, spruce and birch trees, resulting in a by-product of the pulp and paper manufacturing process. Sulzer Chemtech was the first company to introduce the dry vacuum distillation process with the help of structured packing with the lowest pressure drop.

Key Features of Sulzer Chemtech Technology:

- Decades of industrial experience and dozens of in-house pilot tests
- Low pressure drop (bottom temperature < 250-270 °C)
- Small holdup and high-separation performance
- No stripping steam required
- Over 60 industrial column references

Your Benefits with Sulzer Chemtech:

- Competitive product quality (high acid numbers, excellent color values, high softening point)
- Higher yield results from less degradation
- Lower energy consumption
Higher capacity through revamping with MellapakPlus

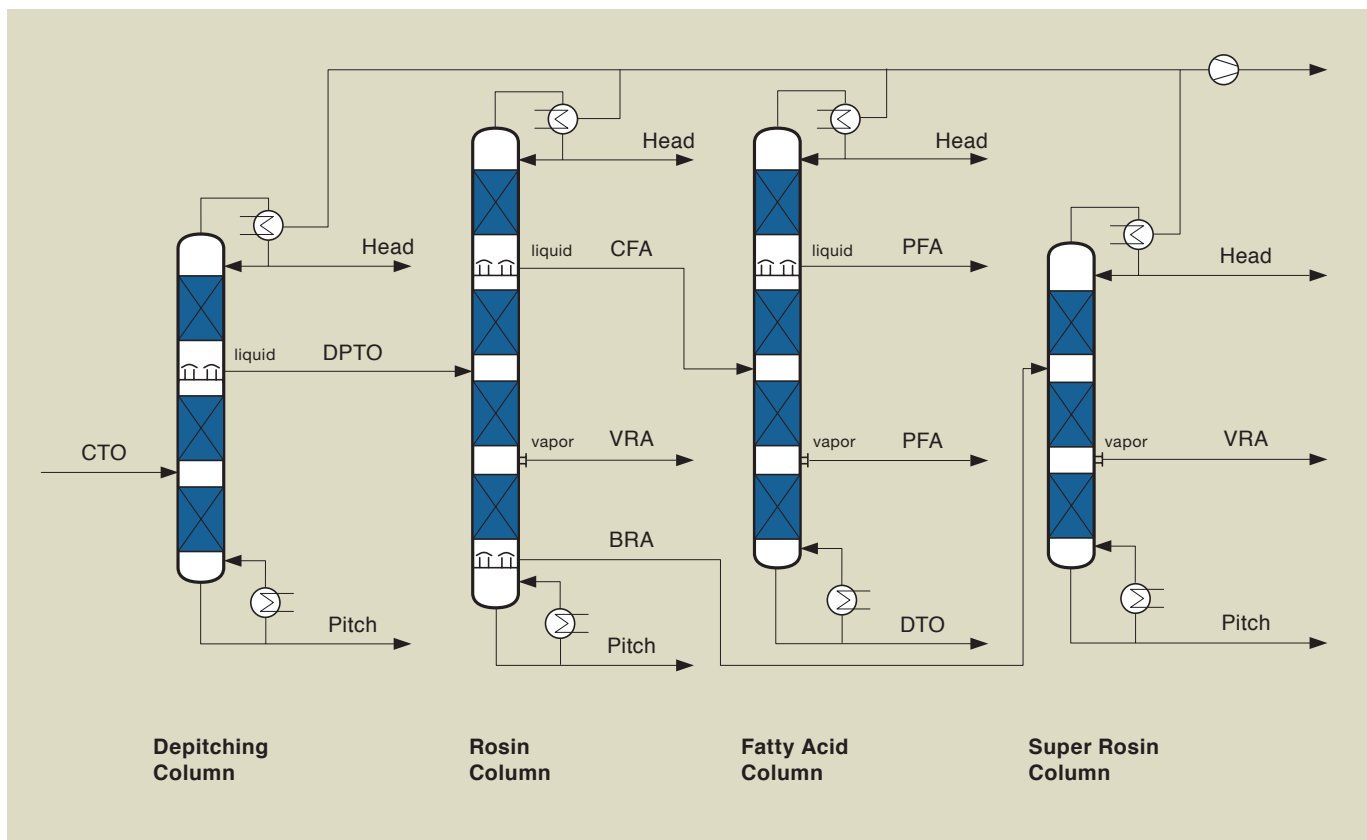

CTO Crude Tall Oil
DPTO Depitched Tall Oil
Head Light Ends

VRA Vapor Rosin Acid
BRA Bottom Rosin Acid
CFA Crude Fatty Acid

DTO Distilled Tall Oil
PFA Pure Fatty Acid
Pitch Heavy Ends

Air Separation Units

The separation of air components (Oxygen, Nitrogen, Argon) using cryogenic distillation as a process route is characterized by high energy requirements reflected in the duty of the main air compressor,

which may be reduced if the pressure drop through the distillation process is kept to a minimum. A reduction of energy requirements is only possible if structured packing is utilized.

- 1 High-pressure column
- 2 Low-pressure column
- 3 Crude argon column
- 4 Pure argon column
- 5 Direct cooler
- 6 Heat exchanger
- 7 Main heat exchanger
- 8 Argon condenser
- 9 Evaporator / condenser
- 10 Air compressor

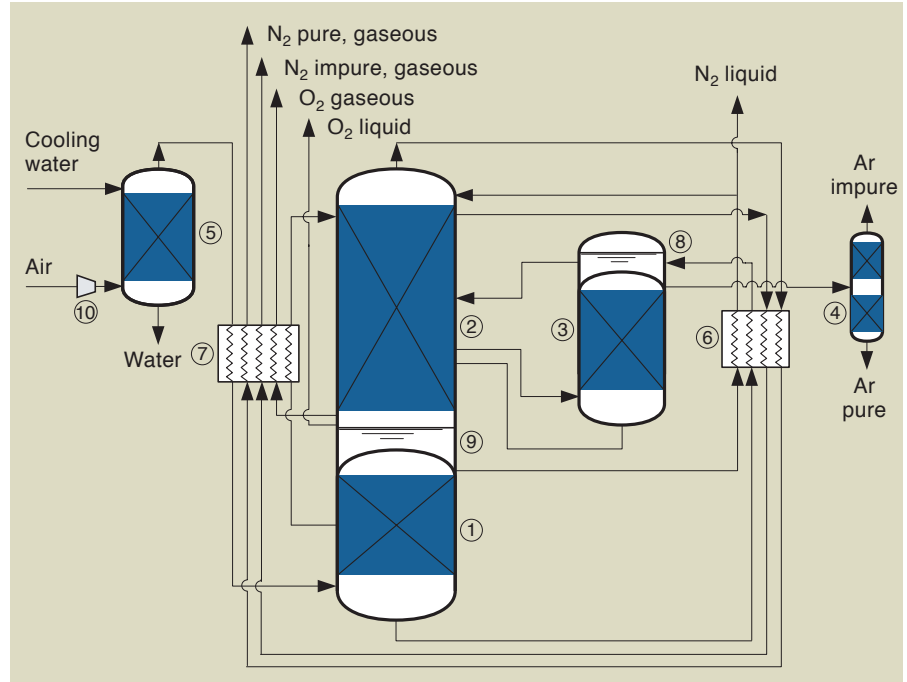

Key Features of Structured Packing

- Low pressure drop
 - Energy saving on air compressor
 - Argon recovery by distillation to 1 ppm O₂
- Higher argon yield and low liquid hold up
- Better column flexibility, quicker response time
 - Larger operating range

Important Criteria with Mellapak / MellapakPlus and Internals

- Low height, high quality internals for air separation
- Packing and internals for field and workshop installation
- Horizontal transportation design validation on vibration table and overseas transport
- High accuracy of liquid distributors (tested on test rig)
- Degreasing to oxygen cleanliness



Vibration test, to simulate transportation of assembled columns / cold boxes



Liquid distributor test to confirm the correct operation range of each distributor

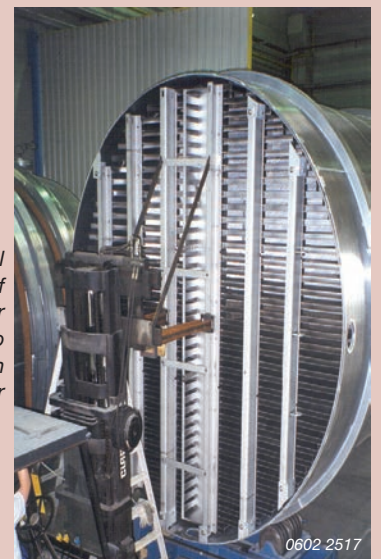

Horizontal installation of liquid distributor in the workshop of column manufacturer

Hydrogen Peroxide / Peracetic Acid

For all of your hydrogen peroxide needs, Sulzer Chemtech provides you with:

- Consulting
- Feasibility studies
- Safety concepts
- Process design
- Basic engineering
- Key components
- Redesign and revamps of existing setups

By adding a feed evaporator, our customers are able to produce hydrogen peroxide of different purities simultaneously. Our plants are designed to produce the entire range of hydrogen peroxide purities of commercial significance, which allows our customers to perfectly position themselves to market opportunities.

H₂O₂ - Safety First!

The maxim of the chemical industry deserves even more attention when dealing with highly active substances such as hydrogen peroxide. Sulzer Chemtech's unique approach to address the safety requirements of hydrogen peroxide has gained wide acceptance around the world. The confidence our customers have in us has made Sulzer Chemtech the market leader in hydrogen peroxide with more than 40 distillation plants in operation worldwide.

The transformation from H₂O₂ to peracetic acid is supported by Sulzer Chemtech with materials testing, computer simulations of reactive distillation processes and joint venture research projects.

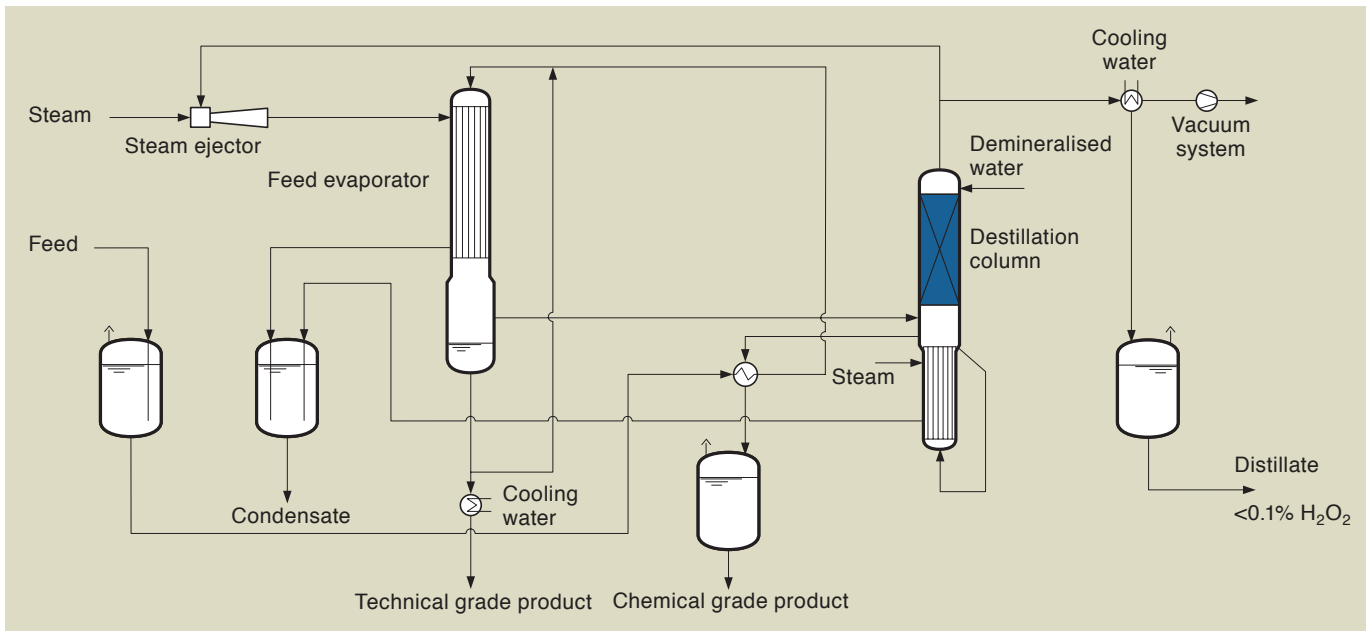

Hydrogen peroxide distillation with feed evaporation

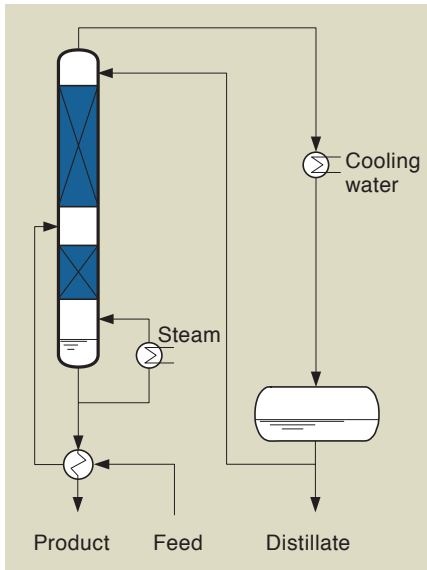

Conventional distillation scheme

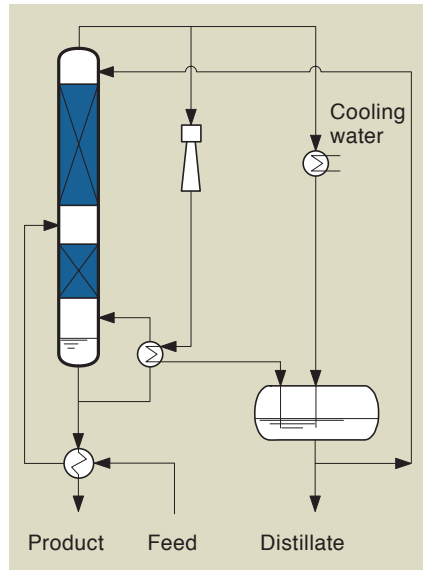

Steam ejector setup, energy saving: 25 to 30%

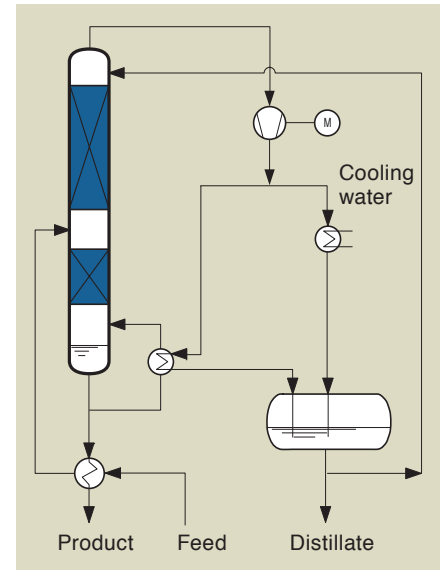

Mechanical vapor recompression, energy saving: 80 to 85%

Steam ejection and mechanical vapor recompression are energy saving technologies that pay off rapidly and, moreover, are approved and subsidized by governments in many countries. These technologies are recognized as state-of-the-art in hydrogen peroxide purification and can be applied to a wide variety of other distillation applications.

The "All In One" unit incorporates reboiler, demister, distillation section and a head condenser in a single shell saving investment cost, installation time and plant space. The concept is also applicable to conventional, steam ejector and vapor recompression modes of operation which will pay off in less than one year depending on the cost of local utilities.



All in one distillation unit

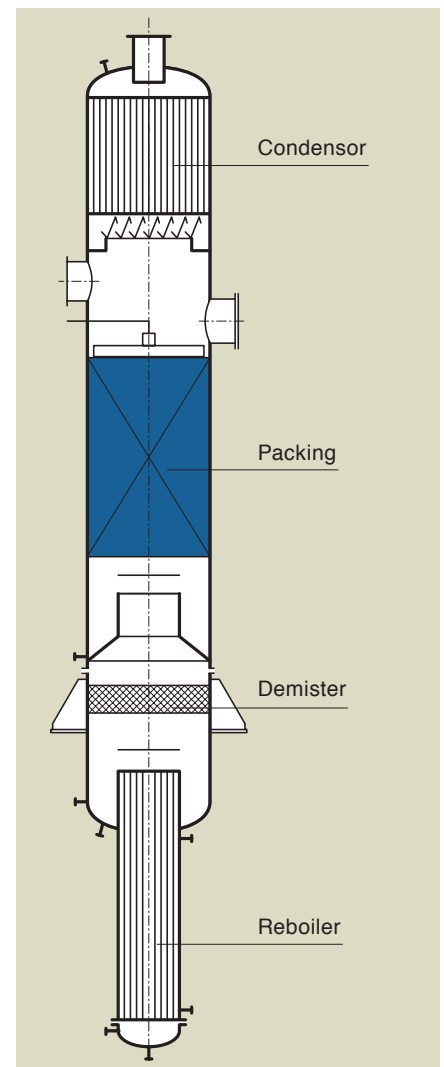

Pharmaceutical Solvents

More and more, the pharmaceutical industry relies on Sulzer Chemtech's vast experience in thermal separation techniques to meet their stringent demands for solvent purity.

If it is to:

- Debottleneck solvent recovery by switching from batch to continuous processing
- Combine various technologies such as distillation, permeation, absorption and crystallization
- Avoid of the buildup of impurities and/or additives during the recovery process
- Bypass the introduction of additives such as entrainers or anti-foaming agents
- Design plants which react fast to changes in operating conditions
- Create processes which adapt themselves to alterations in feedstocks
- Assist with IQ, OQ, PQ and other GMP or FDA requirements

Sulzer Chemtech delivers:

- Concepts
- Feasibility studies (pre-engineering)
- Lab- and pilot-scale tests
- Process design
- Basic engineering
- IQ, OQ, PQ assistance
- Key equipment such as columns, column internals, heat exchangers...
- Modular units (skids)

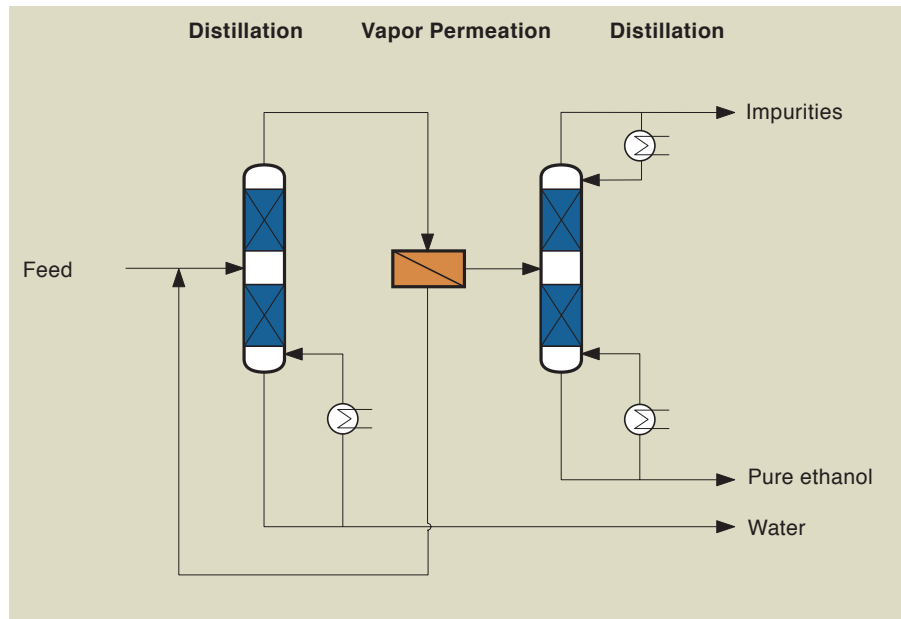

Ethanol absolute without entrainers. The azeotrope is broken by means of a vapor permeation membrane avoiding any concern and effort that come along with the introduction of entrainers or other additives.



Distillation and vapor permeation unit

0603 4401

Acetates

Reversible chemical reactions such as esterifications are ideal systems to be treated by reactive distillation. The unique features of the Katapak® product line include efficient catalyst contacting, high-separation efficiency and high capacity.

Ethyl- and Butyl Acetate Synthesis Methyl Acetate Hydrolysis

Sulzer Chemtech offers technology license and engineering along with components for the esterification of ethanol and butanol with acetic acid to produce ethyl and butyl acetate and the hydrolysis of methyl acetate to produce methanol and acetic acid.

Sulzer Chemtech Acetate Processes Features

- High conversion
- High reaction rate
- Fewer distillation columns compared to conventional process
- No recycle streams
- Low energy consumption
- Heterogeneous catalyst → lower corrosion rate
- Efficient catalyst utilization by applying Katapak-SP
- Precise reaction zones
- Competitively priced

Features of Reactive Distillation

The reactive distillation technology has several advantages, including: a shift of the chemical equilibrium and an increase of reaction conversion by simultaneous separation of the products; suppression of side reactions and utilization of heat of reaction for mass transfer. Compared to conventional designs, these synergistic effects may result in significant economic benefits, such as: (a) lower capital investment, (b) lower energy costs and (c) higher product yields.

Catalytic reactions in distillation columns are often carried out homogeneously (using a liquid

catalyst, e.g. sulfuric acid). Heterogeneous catalysis (solid catalyst) is preferred due to the advantage of avoiding catalyst separation and recycling, which leads to the loss of a product or catalyst. Furthermore, the position and height of the reaction zone in the reactive distillation column can be pinpointed, which reduces the potential of unwanted byproduct formation. Since there is no free acid in the column when applying Katapak-SP, corrosion rates can be reduced significantly and less corrosion resistant materials of construction can be applied, resulting in lower investment costs.

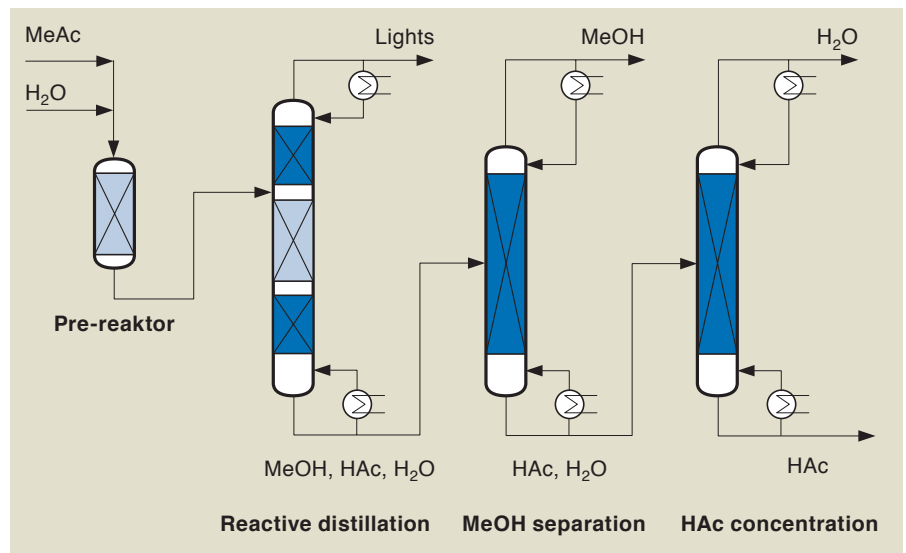

Hydrolysis of methyl acetate process

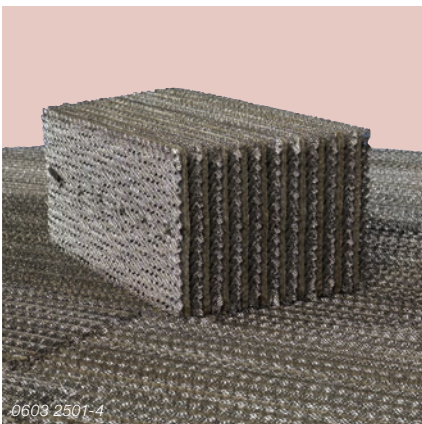

Katapak-SP

Divided Wall Column

- Divided wall columns from Sulzer Chemtech reduce energy and investment costs
- Two columns are combined into one shell
- Three on spec products can be produced with one column
- The dividing wall creates a pre-fractionator on the feed side, which reduces the chance of pollution of the on spec middle product with the feed on the product side

Sulzer Chemtech offers:

- Innovative systems for structured packing and separation trays
- Hydraulic designs for the complete column
- Design and manufacturing for optimal column internals
- Mechanical engineering for columns
- Process design, control and integration

Sulzer Chemtech has produced pilot and industrial divided wall columns with gauze packing, Mellapak, MellapakPlus and trays with diameters ranging from 43 to 4500 mm

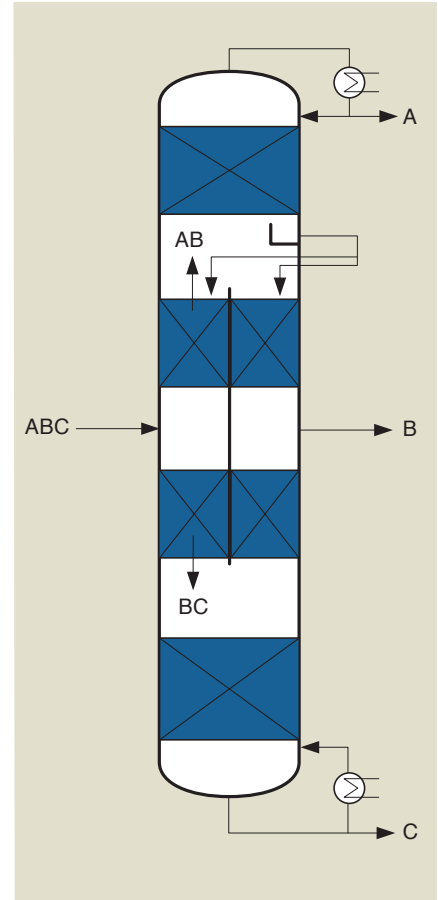
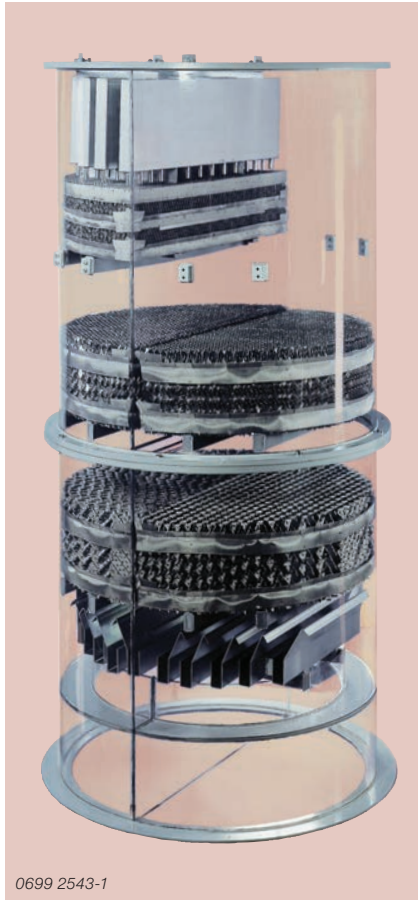

Take Benefit from our Knowhow for most of your Problems

Project management

Purchasing of key equipment
Expediting
Quality assurance

Basic engineering

Process
Process flow diagrams
Piping and instrument diagrams
Control
Specification of equipment
Layout
Preliminary operating instruction

Laboratory

Mobile plant
Pilot test
Absorption test
Distillation test

- Batch
- Continuous
- Total reflux

Column for pressure absorption
Distributor test
Hydraulic test

Process design

Distillation simulation

Study

Feasibility study
Simulation study
Bottleneck analysis
Energy saving

Data analysis from operation

Validation
Trouble shooting
Maldistribution analysis



Detail engineering of key equipment

Columns
Columns internals
Heat exchangers
Vessels
Modules

Startup assistance

Training operator

Additional services and tools

CFD analysis
GC analysis
Column scanning
Sulpak for packing design
Sultray for tray design

Site services

Project planning
Supervision
Installation of internals at site or in workshops
Tower inspection and repair
Maintenance contracts
Spading and despading
Code welding
Nozzles - design and supply
Vessel site construction
Column dressing
Third-party inspections
NTD co-ordination
Revamps
Turnarounds
Column demolition
Project management
Subcontractor coordination
Spare parts supply for trays and other internals

www.sulzer.com

Please check for your local contact

Sulzer Chemtech Ltd, a member of the Sulzer Corporation, with headquarters in Winterthur, Switzerland, is active in the field of process engineering and employs some 4000 persons worldwide.

Sulzer Chemtech is represented in all important industrial countries and sets standards in the field of mass transfer and static mixing with its advanced and economical solutions.

The activity program comprises:

- Process components such as fractionation trays, structured and random packings, liquid and gas distributors, gas-liquid separators, and internals for separation columns
- Engineering services for separation and reaction technology such as conceptual process design, feasibility studies, plant optimizations including process validation in the test center
- Recovery of virtually any solvents used by the pharmaceutical and chemical industry, or difficult separations requiring the combination of special technologies, such as thin film/short-path evaporation, distillation under high vacuum, liquid-liquid extraction, membrane technology or crystallization.
- Complete separation process plants, in particular modular plants (skids)
- Advanced polymerization technology for the production of PLA and EPS
- Tower field services performing tray and packing installation, tower maintenance, welding, and plant turnaround projects
- Mixing and reaction technology with static mixers
- Cartridge-based metering, mixing and dispensing systems, and disposable mixers for reactive multi-component material

Distributed by:

